



IRay Technology Co., Ltd.

Add: 11th Guiyang Street, YEDA, Yantai, P.R. China

Tel: 0086-400-998-3088

Email: infraredoutdoor@infrared.com

Web: www.infraredoutdoor.com

Operating Manual

Hybrid Series | Thermal Imaging Scope

HYH50W / HYH35W

IMPORTANT SAFETY INFORMATION

Environmental influences

WARNING! Never point the lens of the device directly at intense heat sources such as the sun or laser equipment. The objective lens and eyepiece can function as a burning glass and damage the interior components. The warranty does not cover damage caused by improper operation.

Risk of swallowing

Caution: Do not place this device in the hands of small children. Incorrect handling can cause small parts to come loose which may be swallowed.

Safety instructions for use

- Handle the device and Battery Pack with care: rough handling may damage the Battery Pack.
- Do not expose the device to fire or high temperatures.
- Only use the battery charger included in the delivery package.
- The battery capacity decreases when operated in a cold ambient temperature. This is not a fault and occurs for technical reasons.
- Always store the device in its carrying bag in a dry, well-ventilated space. For prolonged storage, remove the batteries.
- Do not expose your device to extreme temperatures lower than - 20°C and higher than + 50°C.
- The product shall only be connected to a USB Type C interface.
- If the device has been damaged or the battery is defective, send the device to our after-sales service for repair.

Safety instructions for the power supply unit

- Check the power supply unit, cable and adapter for visible damage before use.
- Do not use any defective parts. Defective components must be replaced.
- Do not use the power supply unit in wet or humid environments.
- Only use the original cable provided with the battery charger.
- Do not make any technical modifications.

For further information and safety instructions, please refer to the Operation Instructions provided. This is also available on our website in the download center: www.infirayoutdoor.com.

Disposal of batteries

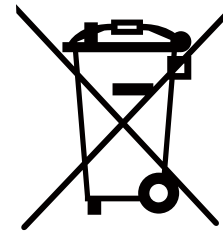

In the European Union, this symbol indicates that the battery used in this product may not be disposed of in domestic waste and must be collected for disposal separately. When returning used batteries, please use a collection system that

may exist in your country. The materials and substances in the batteries may have a detrimental impact on health and the environment.

By depositing empty batteries at a recycling facility, you are contributing to the protection, maintenance and improvement of the quality of our environment.

Please only return discharged batteries.

The battery used does not contain mercury, cadmium or lead in quantities exceeding the limits defined in Directive 2006/66/EC.

User information on the disposal of electrical and electronic devices (private households)

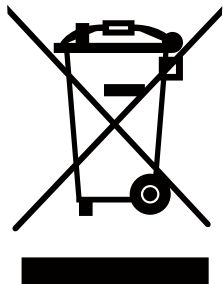

The WEEE symbol on products and/or accompanying documents indicate that used electrical and electronic products must not be mixed with ordinary household waste. For proper treatment, recovery and recycling, take these products to the appropriate collection points where they will be accepted without charge.

In some countries, it may also be possible to return these products to your local retailer when you purchase a corresponding new product. The proper disposal of this product serves to protect the environment and prevents possible harmful effects on human beings and their surroundings, which may arise as a result of incorrect handling of waste.

More detailed information on your nearest collection point is available from your local authority. In accordance with state legislation, penalties may be imposed for the improper disposal of this type of waste.

For business customers within the European Union

Please contact your dealer or supplier regarding the disposal of electrical and electronic devices. He will provide you with further information.

Information on disposal in other countries outside of the European Union

This symbol is only applicable in the European Union. Please contact your local authority or dealer if you wish to dispose of this product and ask for a disposal option.

Intended use

you purchase a corresponding new product. The proper disposal of this product serves to protect the environment and prevents possible harmful effects on human beings and their surroundings, which may arise as a result of incorrect handling of waste.

The device is intended for displaying heat signatures during nature observation, remote hunting observations and for civil use. This device is not a toy for children.

Use the device only as described in this instruction manual. The manufacturer and the dealer accept no liability for damages which arise due to non-intended or incorrect use.

Function test

- Before use, please ensure that your device has no visible damage.
- Test to see if the device displays a clear, undisturbed image.
- Check that the settings for the thermal imaging monocular are correct.

Installing/removing the battery

The Hybrid series thermal imaging monocular is equipped with a Battery Pack. The Battery Pack can be moved and charged, referring to the section 6 Battery Pack for details.

1 Specification

Model	HYH35W		HYH50W	
Resolution, pixels	640×480/12μm			
NETD	≤40mk			
Objective Lens, mm	f35 /F0.9		f50 /F1.0	
Field of View	12.5°x9.4°		8.8°x6.6°	
Recognition Range (Deer)	830m		1180m	
Recognition Range (Vehicle)	1490m		2130m	
Digital Zoom	1X/2X/4X/8X			
Recommended Day Scope Magnification	1X~9X			
Color Palettes	White-hot, black-hot, red-hot, iron-red, rainbow, and outline			
Eye Relief	25~60mm			
Diopter Adjustment	-4D~+2D			
Screen	1.03", 2560×1920 AMOLED			
Battery	3.7V/4400mAh			
Max. Operating Time (at temp.=22 °C)	≥6 h*			
External power supply	5V (USB C)			
Impact	1200g/0.3ms			
Degree of protection, IP code	IP67			
Amount of built-in memory	64GB			
Operating Temperature	-20°C ~ +50°C			
Weight (with battery)	<925g		<940g	
Dimensions (mm)	267×77×76		280×77×76	
APP	Support			
Optional Extended Functions	Bluetooth remote controller Laser rangefinder 1000, with a maximum measuring range of 1,000m (500m for deer) Laser rangefinder 2000, with a maximum measuring range of 2,000m (1,000m for deer)			

- ☆ The actual operating time depends on the intensity of using Wi-Fi, video recorder.
- Improvements may be made to the design and software of this product to enhance its useful features.
- Technical parameters of the device may be improved without prior notice of the customer.

2 Package Contents

- Hybrid thermal scope
- Recoil-absorbing mount
- Portable bag
- Charger
- Tools box
- Lens cleaning cloth
- Infrared sticker
- Infrared card
- Heated target
- Quick start guide

3 Description



The Hybrid thermal scope is a high-end product designed for outdoor hunting. It supports the clip-on mode and rifle-scope mode. It combines detection chips with ultra-high sensitivity to restore the color and details of infrared images during daytime and night. It also has a large ultra HD screen, a comfortable eyesight system with long eye relief, and ballistic calculation. With rich functions and a long working time, it can be widely used for hunting and observation under complex or harsh conditions.

4 Components and Controls

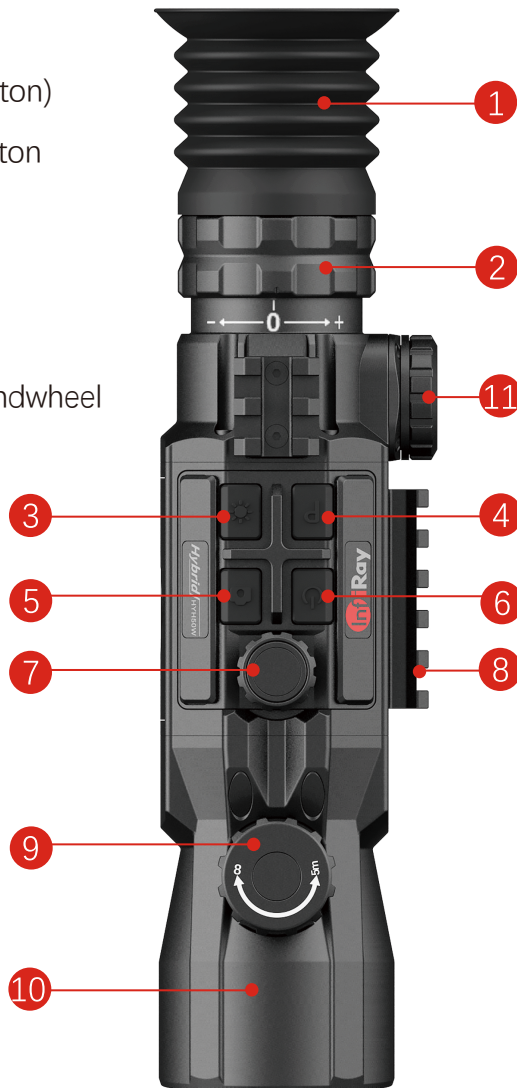



1. Eyeshade of eyepiece
2. Eyepiece diopter adjustment ring
3. Display brightness button
4. Image mode button (P button)
5. Photo/video recording button
6. Power button
7. Rotary encoder
8. External picatinny rail
9. Objective lens focusing handwheel
10. Objective lens
11. USB-C interface



5 Description of Control

Button	Current Mode	Short Press	Press and Hold
 Power Button on the mainframe	Powered off	--	Power on
	Home screen	Image calibration	Power off the device/Standby
	Menu screen	Return to the upper menu without saving changes	--
	Dormant status	Cancel dormant status	--
	Rangefinding module connection	Enable single rangefinding/continuous rangefinding	--
 Menu button (press rotary encoder) on the mainframe	Home screen	Open the shortcut menu	Open the main menu
	Shortcut menu interface	Enter the next menu/confirm option parameters and return to the previous menu	Save and back to the home screen
Main menu interface			
 Menu button (left/right-handed rotate rotary encoder) on the mainframe		Digital zoom	
	Menu screen	Scroll up/down/left/right menu options	--

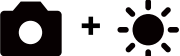
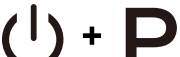
6 Battery Installation

Button	Current Mode	Short Press	Press and Hold
 Capture button on the mainframe	--	Photographing	Video recording
	Recording screen	Photographing	End the recording and save the video
 Image mode button (P button) on the mainframe	Home screen	Switch the observation mode	Switch the image palettes
 Image brightness button on the mainframe	Home screen	Adjust the display brightness	Turn on/off the PIP function
	Home screen	ON/OFF ROI	--
	Zeroing	--	Freeze the image
	Home screen	--	--
	Rangefinder mode	Switch between single and continuous rangefinder modes	Laser rangefinder reticle position adjustment screen
	Home screen	--	Enable/Disable the clip-on mode

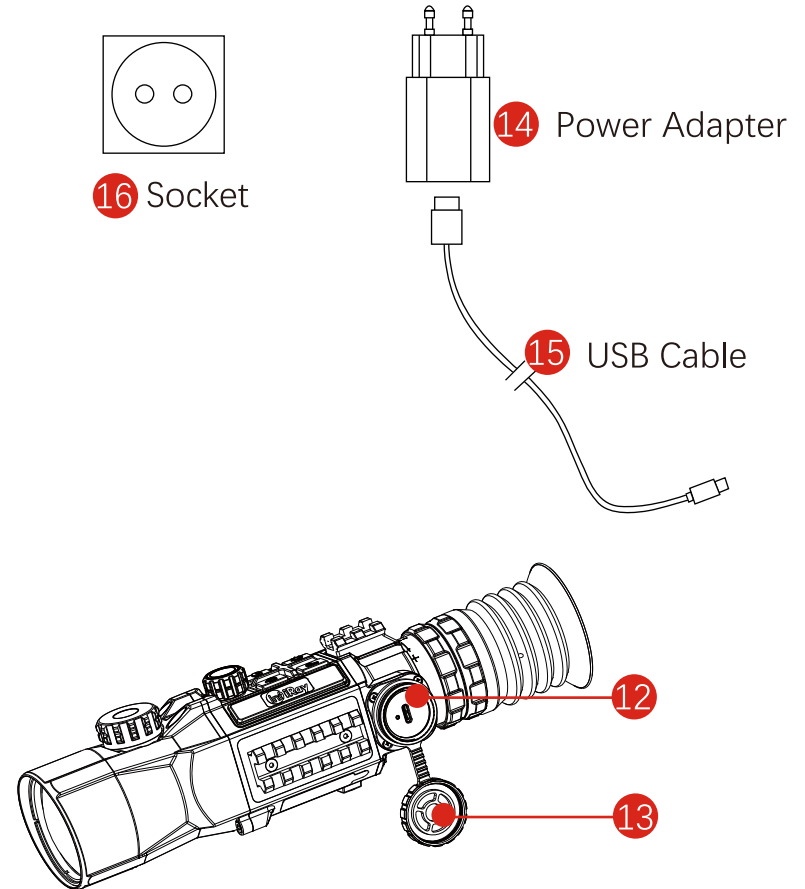

Hybrid is powered by a battery with custom cell, a rechargeable lithium-ion battery pack that provides battery power for up to six hours of normal operation. The battery should be fully charged before first use.

Charging of battery pack

- Open the USB C cover (13);
- Insert the USB C end of the data cable (15) into the USB C socket (12) on Hybrid;
- Connect the other end of the data cable to the power adapter (14), and insert the adapter into a 100-240V power socket (16) for charging;
- When charging, a lightning charging icon appears on the battery icon and the current battery level flashes alternately, and the LED indicator on the device is in red. When the LED indicator turns green, it indicates that the charging is completed.
- During use, when the icon is displayed white inside, it indicates that the battery capacity is higher than 20%, which is sufficient. When the icon turns red, it indicates that the battery capacity is insufficient and should be charged in time to avoid reducing the service life of the device due to over-discharge of the battery.

Precautions

- When charging, please use the 5V2A power adapter compatible with the device. Using any other type of adapter may cause irreversible damage to the battery or the adapter itself;
- If the device is not in use for a long time, the battery should be partially charged, not fully charged or discharged.
- Do not charge the device immediately after it is moved to a warm environment from a cold environment. Wait for 30 to 40 minutes for preheating.
- If the charger is modified or damaged, do not use it;
- The device should be charged at a temperature of 0°C to +40°C. Otherwise, the battery life will be significantly reduced.

- When charging, please do not leave the battery unattended;
- Do not connect the battery to the power supply for more than 24 hours after it is already fully charged;
- It is not recommended to connect third-party devices that consume more energy than the allowed value.
- The device is equipped with a short circuit protection system, but conditions that may lead to a short circuit should be avoided.
- The recommended operating temperature for the device is from -20°C to +50°C. Do not use the device beyond this temperature range, or else, it may shorten the battery life.
- When the device is used under sub-zero temperature, the battery capacity drops. This is normal and does not indicate a defect.

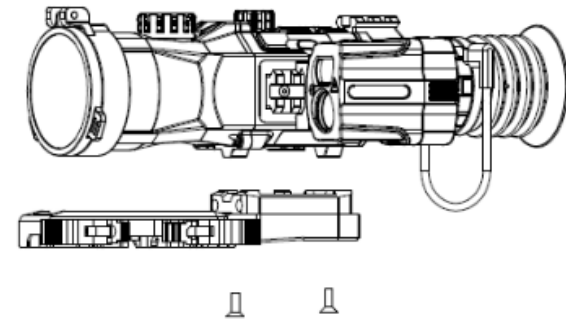

7 External Power Supply

- Hybrid supports external power supplies, such as the portable power source for a mobile phone (5V).
- Connect an external power supply to the USB C port (12) of Hybrid; Then, the device automatically switches to the external power supply and charge the internal battery pack at the same time;
 - When the external power is turned off, the device will switch to the battery pack for the power supply.

8 Installation and Usage

Fixed installation

WARNING! The lens of the device must not be pointed at any sources of intense radiation energy, such as laser-emitting devices or the sun. This may damage the electronic components in the device. Damage caused by failure to comply with the operating guidelines is not covered under warranty.

To ensure shooting accuracy, please fix the Hybrid at a proper picatinny rail position on the equipment.

- Fixing Hybrid requires the use of a vibration-absorbing support provided in the packaging, as follows:
 - Find the beveled notch of the vibration-absorbing support and align it with the bevel at the bottom of the product
 - Use the support screw (M3×10 inner hexagon screw) and fixing wrench (M2.5 inner hexagon wrench) attached to the package to fix the vibration-absorbing support at the bottom of the device
- The installation position of the Hybrid device should be adjusted according to the distance between the eye and eyepiece (eye relief) as specified in the specifications and the sense of use and comfort. If you fail to follow this suggestion, the eyepiece may hurt the shooter during the shooting.
- It is recommended to install the scope as low as possible, but keep it away from the barrel or other devices;

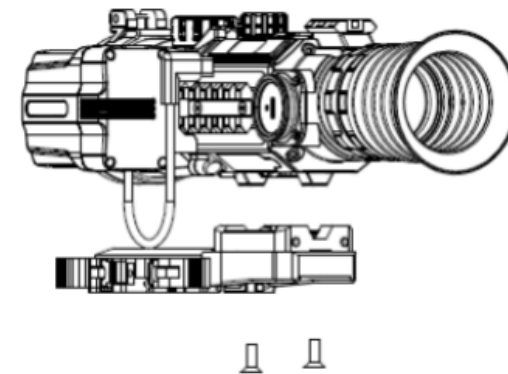

- It is recommended to use a torque wrench to tighten the screws of the installation clamps, so as to avoid damaging the support locking mechanism due to being over-tightened, and the recommended torque shall not exceed 2.5Nm;
- When the scope is used for shooting or hunting, please carry out the zeroing operation first according to the instructions as specified in "**Chapter 9 "Zeroing"**" in this manual;
- The optional installation steps of laser accessories are as follows:
 - Fix the laser rangefinding module to the picatinny rail on the left side of the scope.
 - Connect the USB C cable for laser rangefinding to the USB C interface of the scope.



Power on and settings

- Open the lens cap ; **if the outdoor sunlight is relatively strong, pay attention not to face the lens to the sunlight to avoid burns;**
- Press and hold the power button (4) for 3s to power on the device;



- Rotate the eyepiece diopter ring (2) until the icon on the screen is clear;
- Rotate the objective lens focus ring (9) to adjust the focus length;
- To set the image mode: On the home screen, press the P button (4) to set the image mode, which is clear  -bird watching  -penetrating fog  in sequence, and the icon on the top status bar is updated in real-time;
- To set the color palette: On the home screen, press and hold the P button (4) to switch the color palette to white-hot, black-hot, red-hot, iron-red, rainbow, and outline in sequence. The icon on the top status bar is updated in real time;
- To set the display brightness: On the home screen, press the display brightness button (3) to set the screen brightness, which can be switched between level 0 to level 9, and meanwhile, a short prompt for the corresponding brightness icon appears at the bottom left corner of the display;

- To set the image sharpness: Press the rotary encoder (7) to enter the shortcut menu and set the image sharpness (refer to Chapter "Shortcut Menu" for details);
- To select the rifle scope and clip-on mode: Default rifle scope mode when power on. Press and hold the Capture button while pressing the rotary encoder to switch to clip-on mode from the rifle scope mode (default mode).
- After use, press and hold the power button (6) for 3 seconds and a shutdown countdown is displayed. When the countdown icon turns from 3 to 0, release the button, a prompt interface "Data saving ..." is displayed. When the data is saved, the display turns black and the device is off. **When the device is powering off and saving data, do not disconnect it from the power source. Otherwise, the data cannot be saved.**
- Press and hold the Power button (6) for 3 seconds, and the shutdown countdown appears. Before the countdown icon turns from 3 to 0, release the button, then the device enters the standby mode. To wake up the device, press the Power button (6).

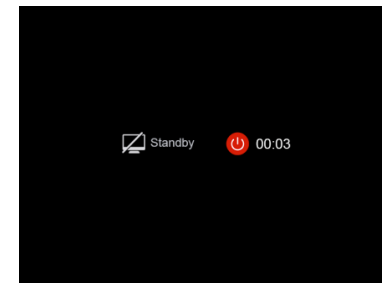

- * Under the clip-on mode, the recommended day scope magnification is 1×~9×.

9 Zeroing

Hybrid adopts the "freezing" zeroing method. It is recommended to carry out the zeroing operation within the range of operating temperature of the scope.

- Fix the scope on the weapon with a support;
- Select a target at a certain distance, such as 100 meters, 200 meters, etc.;
- Adjust the scope according to the operating instructions as described in **Chapter 7 Power On and Settings**;
- Select the zeroing profile;
- Press and hold the rotary encoder (7) to enter the advanced menu screen, select the return-to-zeroing adjustment option, and press the rotary encoder (7) to enter the submenu of the zeroing function;
- According to the selected target distance, select or add the new zeroing distance (refer to "**Zeroing-Zeroing Distance**" in the advanced menu);
- When the zeroing distance is set up, turn the encoder (7) to select the zeroing function, and press the encoder (7) to go to the zeroing screen (refer to "**Zeroing -Reticle Position-Zeroing Screen**" in the advanced menu). The coordinate positions of the reticle (X axis and Y axis) are displayed in the upper left corner of the display;
- Shoot at the target;
- Observe the position of the actual point of impact, and assume that the red mark × in the figure on the right is the position of the point of impact (This mark is only for illustration. It should actually be a bullet hole);



- If the point of impact and the aiming point (the center point of the reticle) do not match each other, keep the aiming position still, and meanwhile, press the photographing/video recording button (5) + the image brightness button (3) to freeze the picture, and then a snow-like freezing icon appears on the left of the display ;
- Turn the rotary encoder (7) to move the reticle, rotate clockwise to move the cursor left or down, and rotate anticlockwise to move the cursor right or up;
- Press the rotary encoder (7) to switch between the X axis and Y axis, and the position where the icon is highlighted indicates the currently selected item, with the icon turns blue;
- After moving the reticle, a little white dot appears on the display, indicating the position of the reticle before moving;
- After moving the reticle position to the actual point of impact, press and hold the rotary encoder (7) to save the current reticle position and return to the main screen of the advanced menu;
- Repeat aiming and shooting, until the position of the point of impact is consistent with that of the aiming point.



Note:

After the zeroing positions at different distances are set up, you can switch the options of zeroing distance in the shortcut menu.

10 Digital Zoom

The Hybrid scope can digitally zoom the image by 1X, 2X, 4X, and 8X.

- On the home screen, turn the rotary encoder (7) to zoom in/out the image;
- Zoom in by rotating clockwise, and zoom out by rotating anticlockwise;
- The magnification is displayed at the status bar of the display area in real time.

11 Photographing and Video Recording

Hybrid has built-in 64GB memory space to support photographing and video recording. The image and video files will be named after time, so it is recommended to set the system date and time settings in the advanced menu before using the photographing and video recording functions (refer to "**Advanced Menu-Settings-Date/Time Setting**").

Photographing

- On the home screen, press the **capture button** (5) to take a photo, and a photo icon appears on the left side of the display;
- The images taken are saved in the built-in storage.



Video recording

- On the home screen, press and hold the **capture button** (5) to start the video recording;
- A recording icon and a prompt box showing the recording time will appear in the upper right corner of the display, with the time format as 00:00:00 (hour: minute: second);
- During recording, you can also take a photo by pressing the **capture button** (5);

- Stop the recording and save the video recording by pressing and holding the **capture button** (5);
- The videos and images taken are saved in the built-in storage.



Note:

- You can enter and work on the menu during video recording.
- All images taken and videos recorded will be saved in the built-in memory card in the formats of IMG_YYYYMMDDhmmss_XX.jpg(photos)and VID_YYYYMMDDhmmss_XX.mp4 (videos); YYYYMMDDhmm refers to year/month/day/hour/minute/second/, and XX refers to the serial number of two-bit multimedia file;
- The serial number of the multimedia file cannot be reset;

Note:

- The maximum duration of a video recording file is 5 minutes. When the duration is more than 5 minutes, the video will be automatically recorded onto a new file;
- The number of files is fixed and limited by the memory space of the device. Each device can store 1,800 photos, 600 videos and 370 recoils automatic recorded videos. Beyond this amount, the oldest photos or videos are automatically replaced. Please regularly transfer the material and photos to other media to release space of the memory card.
- The interface icon information is not displayed on the captured video or image.

Memory access

When the device is powered on and connected to a computer, it will be recognized by the computer as a flash memory card. Then, you can access the memory of the device and copy images and videos.

- Connect the device to a computer through the data cable;
- Power on the device;
- Double click "My Computer" on the desktop of the computer, find the device named "U disk" and double click to open folders named "VIDEO-CIF", "PHOTO-CIF" and (RAV-CIF) to access photos and videos;
- Open the memory file, and there are different folders named after time in the format of xx (day)xx (month) xxxx (year) in it;
- Select required files or folders to copy or delete.

Note:

-After the device is connected to the computer, it prompts that only part of the memory is available. This is because the storage algorithm mechanism adopted by the device is different from that of the computer and does not represent the actual memory occupation. Please check the actual memory in Hybrid's device file management.

-After connecting to the computer, do not use the formatting tool to format the device. Instead, do it with the corresponding tool on the menu.

12 Status Bar



The status bar is located at the top, sidebar, and bottom of the image interface and displays the information related to the current operating status of the device. From left to right, there are:

1. Analogue video status
2. Current image mode (such as bird watching mode)
3. Current palette mode (such as black hot)
4. Current zeroing gun type (after the hidden reticle function is enabled)
5. Current zeroing ammo type (after the hidden reticle function is enabled)
6. Calibration mode (manual calibration, automatic calibration, background calibration)
7. Azimuth angle
8. Digital zoom
9. Built-in microphone switch
10. Battery level
11. Current time
12. Wi-Fi switch
13. Bluetooth switch

The angle of pitch and angle of inclination are on the right side, and the target distance is on the left side. The bottom status bar is the current zeroing distance value and the dormancy duration status in turn.

13 Shortcut Menu

On the shortcut menu, you can quickly adjust the basic configurations of commonly used functions, including image brightness, image contrast, image sharpness, calibration method, target distance, reticle type, reticle color, and quick reticle position. Press the rotary encoder (7) to confirm saving, and press the power button to exit to the home screen.

- On the home screen, press the **rotary encoder** (7) to go to the shortcut menu screen;
- Turn the **rotary encoder** (7) to switch between the following function options, and the icon background of the selected option will be highlighted:
 - Image brightness**: Turn the **encoder** (7) to select the option, and press the **encoder** (7) to adjust the image brightness from level 0 to 9;
 - Image contrast**: Turn the **encoder** (7) to select the option, and press the **encoder** (7) to adjust the image contrast from level 0 to 9;
 - Image sharpness**: Turn the **encoder** (7) to select the option, and press the **encoder** (7) to adjust the image sharpness from level 0 to 9;
 - Calibration method**: Turn the **encoder** (7) to select the option, and press the **encoder** (7) to adjust the shutter correction method;
 - Zeroing distance**: Turn the **encoder** (7) to select the option, and press the **encoder** (7) to set the target distance;
- The following are the options after opening the hidden menu:
 - Reticle type**: Turn the **encoder** (7) to select the option, and press the **encoder** (7) to switch between 7 reticle types;
 - Reticle color**: Turn the **encoder** (7) to select the option, and press the **encoder** (7) to switch between 5 reticle colors;
 - Quick reticle adjustment**: Turn the **encoder** (7) to select the option, and press the **encoder** (7) to switch between 3 reticle positions;
- Press the **power button** (6) to return to the home screen.

Note:

After the status bar is automatically hidden and the shortcut menu is opened, if there is no operation within 10s, the device will return to the home screen.

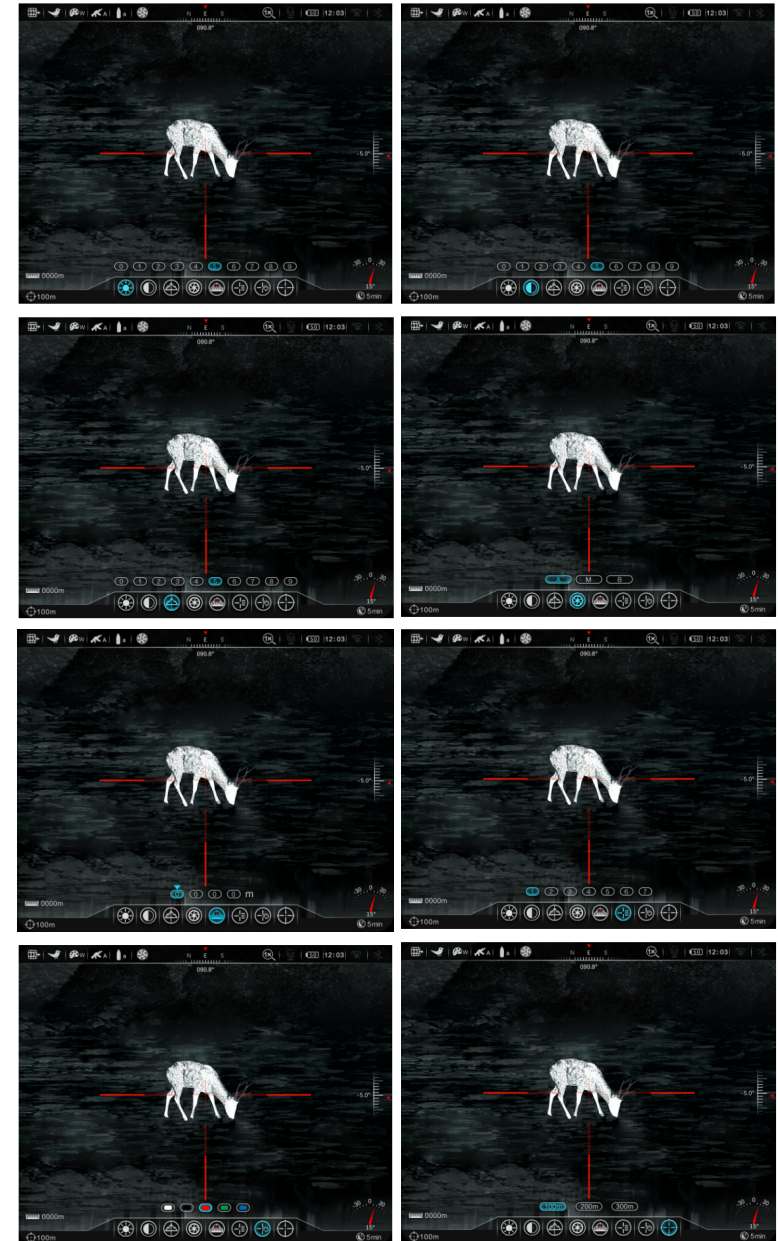

14 Advanced Menu

- On the home screen, press and hold the rotary encoder (7) for 3s to go to the main menu;
- Turn the rotary encoder (7) to switch between the function options in the main menu, rotate clockwise to move right and anticlockwise to move left;
- Press the rotary encoder (7) to modify the parameters of the current option or go to the submenu;
- In any menu screen, press and hold the rotary encoder (7) to save the changes and return to the upper menu. Press the power button (6) to return to the upper menu without saving the changes;
- In any menu screen, the device will automatically return to the home screen without saving the changes when there is no operation within 15s.

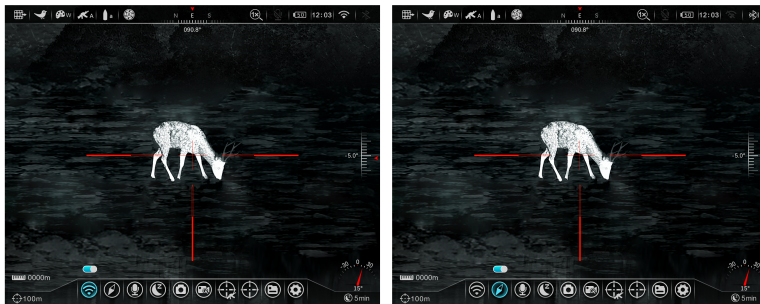

Main Menu Features and Descriptions



Wi-Fi

- Press and hold the rotary encoder (7) to enter the main menu;
- Turn the rotary encoder (7) to select the "Wi-Fi" function option;
- Press the rotary encoder (7) to enable/disable Wi-Fi;
- When the function is turned on or off, the icon in the status bar changes accordingly.



Digital
compass

- Press and hold the rotary encoder (7) to enter the main menu;
- Turn the rotary encoder (7) to select "Digital Compass";
- Press the rotary encoder (7) to enable/disable the digital compass function;
- There will be a change in the information about the corresponding position in the status bar after this mode is turned on or off.



 **Microphone**

- Press and hold the rotary encoder (7) to enter the main menu;
- Turn the rotary encoder (7) to select the "Microphone";
- Press the rotary encoder (7) to enable/disable microphone;
- When the function is turned on or off, the icon in the status bar changes accordingly.



 **Automatic dormancy**

- Press and hold the rotary encoder (7) to enter the main menu;
- Turn the rotary encoder (7) to select "automatic dormancy";
- Press the rotary encoder (7) to select automatic dormancy duration or disable dormancy;
- When turned on/off, the device will enter the on-time dormancy or normally on state. If no operation is carried out for more than 60 minutes after dormancy, the device will automatically shut down.

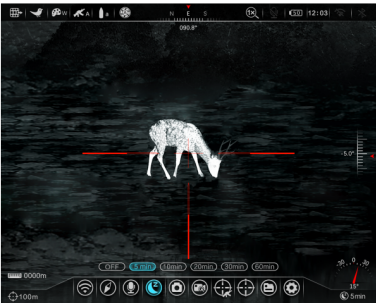

 **Photographing settings**

- Press and hold the rotary encoder (7) to enter the main menu;
- Turn the rotary encoder (7) to select "Photographing";
- Press the rotary encoder (7) to select single photographing; multiple photographing; delayed photographing

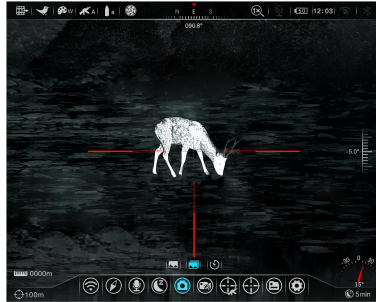

 **Recoil activated video**

- Press and hold the rotary encoder (7) to enter the main menu;
- Turn the rotary encoder (7) to select "Recoil Activated Video";
- Press the rotary encoder (7) to enable/disable recoil activated video;
- The icon on the left side of the screen changes accordingly after this mode is turned on or off.





Zeroing profile Reticle

- Press and hold the rotary encoder (7) to enter the main menu;
- Turn the rotary encoder (7) to select "Zeroing Profile";
- Press the rotary encoder (7) to open the secondary menu of "Zeroing Profile";
- Turn the rotary encoder (7) to select the "Gun Type/Bullet Type/Shooting Table/Shooting Table Reticle Switch/Ballistic Calculation Switch";
- Press the rotary encoder (7) to confirm the selection, and go to the submenu.
- When "Gun Type" is selected, press the menu button to call out the gun type selection interface, and turn the rotary encoder to adjust the gun type. Gun type has "A/B/C" options. Press the menu button to confirm selection and return to the upper menu, press the power button to return to the upper menu, press and hold the menu button to return to the home screen.
- When "Bullet Type" is selected, press the menu button to call out the bullet type selection interface, and turn the rotary encoder to adjust the bullet type. Gun type has "1/2/3" options. Press the menu button to confirm selection and return to the upper menu, press the power button to return to the upper menu, and press and hold the menu button to return to the home screen.
- When "Shooting Table" is selected, press the menu button to call out the interface of entered shooting table, and you can view the entered distance and corresponding offset. See **Chapter 19 Shooting Table Entering** for specific operations.
- When "Shooting Table Reticle Switch" is selected, press the menu button, the open/close button appears, turn the rotary encoder, and select open/close circularly. When opened, the shooting table reticle can be started. **The center of the shooting table reticle is the same as the aiming reticle position under the current zeroing distance, and the zeroing distance is taken as the starting point to display the corresponding aiming point positions under different target distances.**

- When "Ballistic Calculation Switch" is selected, press the menu button, the open/close button appears (if the shooting table reticle is also opened), turn the rotary encoder, and select open/close circularly. When the ballistic calculation is turned on and the system knows the target distance, it can automatically generate a new aiming point superimposed on the shooting table reticle. (**See Chapter 18 for detailed operation**)

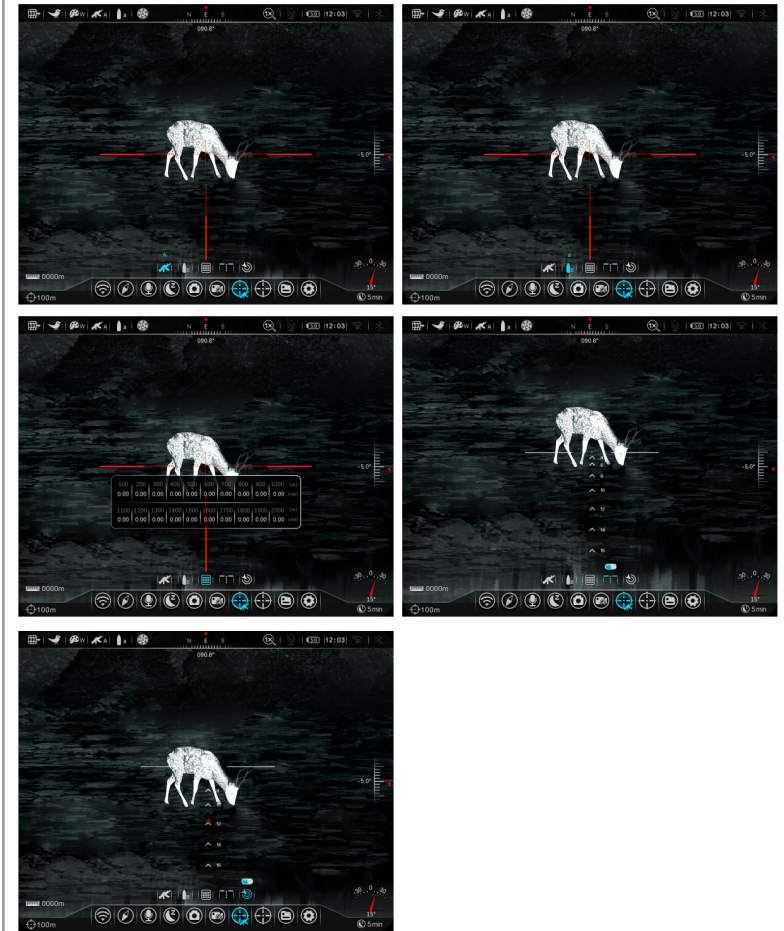



Zeroing

Please set up the gun type, bullet type and zeroing distance before carrying out any zeroing operation.

Hybrid supports any zeroing distance between 001 and 999 meters.



- Press and hold the rotary encoder (7) to open the advanced menu;
- Turn the rotary encoder (7) to select the "Zeroing" in the main menu;
- Press the rotary encoder (7) to open the secondary menu of the zeroing function, which displays 3 zeroing distances;
- Turn the rotary encoder (7) to select the zeroing distance (001-999m) according to the distance set for the target;
- Press and hold the rotary encoder (7) to confirm the zeroing distance, and open the zeroing distance submenu, including two options, that is "Zeroing" and "Zeroing Distance";









Zeroing

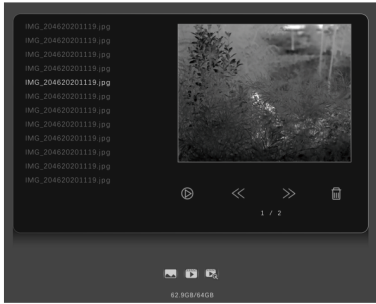

- If the preset zeroing distance is consistent with that displayed on the device, you can perform zeroing directly following the steps as below:
 - Turn the rotary encoder (7) to select **Zeroing**;
 - Press the rotary encoder (7) to go to the zeroing screen;
 - The X axis and Y axis coordinates of the reticle are displayed on the top left corner of the display;
 - Aim the reticle center of the scope at the bull's eye at the target distance and shoot, and then observe the position of the actual point of impact;
 - Keep the aiming position still, and meanwhile press and hold the brightness button (3) and the capture button (5) to freeze the picture, and meanwhile, the freezing icon is displayed on the display;
- Turn the rotary encoder (7) to move the reticle position, until the reticle center aims at the position of the point of impact. For details, refer to **Chapter 9 "Zeroing"**.





	<p>Setting the Zeroing Distance</p>	<ul style="list-style-type: none"> ➤ Turn the encoder (7) to select "Setting the Zeroing Distance"; ➤ Press the rotary encoder (7) to activate the zeroing distance reset function, and then a small triangle symbol is displayed above the number; ➤ Turn the rotary encoder (7) to set the number value of the current position, which can be switched between 0 to 9; ➤ Press the rotary encoder (7) to switch between the positions of hundreds, tens and ones digits; ➤ After setting, press and hold the encoder (7) to save the setting and exit. The cursor returns to the zeroing option, and meanwhile the zeroing distance changes accordingly; ➤ Besides, the status bar updates to the new zeroing distance synchronously. 
 <p>File management</p>	<ul style="list-style-type: none"> ➤ In the main menu, turn the rotary encoder (7) to select the "File Management" option; ➤ Press the rotary encoder (7) to enter the file management interface, which consists of file list, file information, thumbnail and storage information; ➤ The rotary encoder (7) can be switched in the image list, video list and recoil activation video; 	

	<ul style="list-style-type: none"> ➤ Press the rotary encoder (7) to confirm the selection and view the files in the corresponding functions; ➤ Press the power button to return to the upper menu; 
 <p>Advanced settings</p>	<p>Set analog video, Bluetooth, status bar automatic hiding, date and time, compass calibration, blind pixel correction, color temperature switching, unit switching, formatting SD card, restoration of factory settings and equipment information.</p> 
 <p>Analog Video</p>	<ul style="list-style-type: none"> ➤ Press the rotary encoder (7) to open the secondary menu of "Advanced Settings". ➤ Turn the rotary encoder (7) to select "Analog Video"; ➤ Press the rotary encoder (7) to enter the "Analog Video" enabling page ➤ Turn the rotary encoder (7) to set the correct "Analog Video" state; then press the rotary encoder (7) again to exit the selection state ➤ Press the power button (6) to return to the upper menu;

 <p>Bluetooth status</p>	<ul style="list-style-type: none"> ➤ Press the rotary encoder (7) to open the secondary menu of "Advanced Settings". ➤ Turn the rotary encoder (7) to select "Bluetooth Status"; ➤ Press the rotary encoder (7) to enter the "Bluetooth Status" enabling page ➤ Turn the rotary encoder (7) to set the correct "Bluetooth Status" state; then press the rotary encoder (7) again to exit the selection state ➤ Press the power button (6) to return to the upper menu; ➤ After the Bluetooth setting is enabled, it can be used with the Bluetooth remote controller. When the hard switch of the Bluetooth remote controller is turned on, it will automatically connect with the device and support remote control of the device. 
 <p>Automatic hiding of status bar</p>	<ul style="list-style-type: none"> ➤ Press the rotary encoder (7) to open the secondary menu of "Advanced Settings". ➤ Turn the rotary encoder (7) to select "Status Bar Automatic Hiding"; ➤ Press the rotary encoder (7) to enter the "Status Bar Automatic Hiding" enabling page

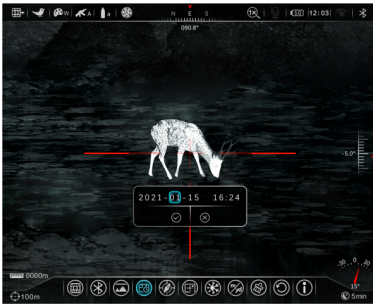
	<ul style="list-style-type: none"> ➤ Turn the rotary encoder (7) to set the enabling/disabling of "Status Bar Automatic Hiding"; enable the function, and if the device is not operated in 15s, the status bar and some UI information will be automatically hidden to obtain a larger FOV. Press the rotary encoder (7) again to exit the selection state ➤ Press the power button (6) to return to the upper menu; 
 <p>Date and time</p>	<ul style="list-style-type: none"> ➤ Press the rotary encoder (7) to open the secondary menu of "Advanced Settings". ➤ Turn the rotary encoder (7) to select "Date and Time"; ➤ Press the rotary encoder (7) to activate the date setting function, with the time in the format of year/month/day/hour/minute. ➤ Turn the rotary encoder (7) to set the correct year, month, day, hour and minute; ➤ Press the rotary encoder (7) to switch between year, month, day, hour and minute; ➤ After the setting is completed, press the encoder (7) in the position √ to save and exit. ➤ The time setting can be automatically synchronized after the APP is connected.





**Compass
Calibration**

- Press the rotary encoder (7) to open the secondary menu of "Advanced Settings".
- Turn the rotary encoder (7) to select "**Compass Calibration**";
- Press the rotary encoder (7) to enter the "Compass Calibration" page
- Rotate the Hybrid device along the three axial directions shown in the icon, and set the correct "Compass Calibration" state by at least 360° rotation in each axial direction;
- Exit automatically when setup is complete

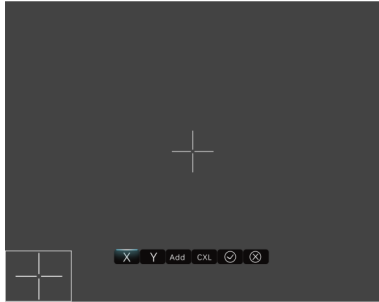

**Pixel Defect
Correction**

- Press the rotary encoder (7) to open the secondary menu of "Advanced Settings".
- Turn the rotary encoder (7) to select "**Pixel Defect Correction**";
- Press the rotary encoder (7) to enter the "Pixel Defect Correction" page. On the pixel defect correction interface, the pixel defect correction cursor appears, and there are four position options of "X, Y, √, ×". Press the menu button to enter the corresponding position, and press the power button to return to the upper menu.
- Select X, press the menu button to enter the X direction adjustment, slowly turn the rotary encoder to move the cursor, move 1 pixel each time, press and hold the rotary encoder to rotate, move 10 pixels each time, and press the power button to return to the 4 positions selection interface to select Y;
- Select Y, press the menu button to enter the Y direction adjustment, slowly turn the rotary encoder to move the cursor, move 1 pixel each time, press and hold the rotary encoder to rotate, move 10 pixels each time, and press the power button to return to the 4 positions selection interface to select √ and ×;
- Select "√" for pixel defect correction, and automatically return to the main menu after correction. Select "×" to exit pixel defect correction and return to the main menu.
- Press the power button (6) to return to the upper menu;



- Press the rotary encoder (7) to open the secondary menu of "Advanced Settings".
- Turn the rotary encoder (7) to select "**Color Temperature Switching**";
- Press the rotary encoder (7) to enter the "Color Temperature Switching" page, with "W" and "C", representing warm and cold colors respectively
- Turn the rotary encoder (7) to set the correct "Color Temperature Switching" state; then press the rotary encoder (7) again to exit the selection state
- Press the power button (6) to return to the upper menu;



**Color
Temperature
Switching**



**Unit
Switching**

- Press the rotary encoder (7) to open the secondary menu of "Advanced Settings".
- Turn the rotary encoder (7) to select "**Unit Switching**";
- Press the rotary encoder (7) to enter the "Unit Switching" page, with "m" and "yd", representing meter and yard respectively
- Turn the rotary encoder (7) to switch the unit; then press the rotary encoder (7) again to exit the selection state
- Press the power button (6) to return to the upper menu;



**SD Card
Formatting**

- Press the rotary encoder (7) to open the secondary menu of "Advanced Settings".
- Select "**SD Card Formatting**", and press the rotary encoder (7) to enter;
- Turn the rotary encoder (7) to select Yes or No; then press the rotary encoder (7) again to exit the selection state
- Press the power button (6) to return to the upper menu;

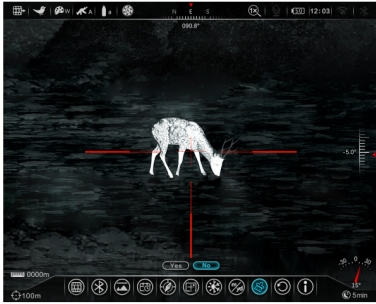

- Press the rotary encoder (7) to open the secondary menu of "Advanced Settings".
- Select "**Factory Reset**", and press the rotary encoder (7) to open the secondary menu for factory reset;
- Turn the rotary encoder (7) to select Yes or No, "Yes" for restoring factory settings or "No" for canceling the operation;
- Press the rotary encoder (7) to confirm the selection;
- After the Factory Reset is selected, the following functions will be restored to default settings:
 - Image Mode: Clean;
 - Image Palette: White hot
 - Zeroing Distance: 100m
 - Digital Zoom: $\times 1.0$;
 - ROI: Off;
 - Wi-Fi: Off
 - PIP: Off
 - Pixel Defect Correction: reserve user's defective pixel data
 - Status Auto Hiding: Off



- Press the rotary encoder (7) to open the secondary menu of "Advanced Settings".
- Turn the rotary encoder (7) to select "**Device Information**";
- Press the rotary encoder (7) to query the relevant information about the current scope;
- Press the power button (6) to return to the upper menu;

15 PIP Function

Picture-in-Picture (PIP) provides a floating window independent of the full screen. This window shows part of the image which is enlarged to 2 \times in a certain area centered on the reticle of the main image.

- On the home screen, press and hold the Display brightness button (3) to enable or disable PIP;
- After enlarging the image on the home screen by turning the encoder (7), the image shown in the PIP window is also enlarged to 2 \times .

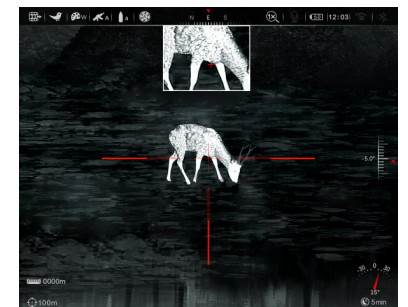

16 ROI

Hybrid has a ROI, which can highlight and mark the target of the central region.



- In the observation interface, **press the capture button (5) + brightness button (3) at the same time** to enable or disable ROI.
- In the main menu, select the option shown in the figure above, press the rotary encoder (7) to confirm, and turn the rotary encoder. After confirming the status, press the rotary encoder to exit.
- After enabling, a circular area with high contrast and high brightness will appear in the middle of the image;
- Press the power button (6) to return to the home screen.





17 Clip-on Function of the Device

Hybrid supports the clip-on mode, which makes it possible to observe thermal images using a day scope (1×–9×).

You may contact your supplier or agent to obtain the video tutorial on clip-on mode installation.

As shown in the operating flow chart, to enable the clip-on mode, press and hold the Capture button  + Menu button  (press the rotary encoder) at the same time when the home page is displayed to switch to the clip-on mode.

In clip-on mode, the menu changes to a simpler layout with the screen centered, which removes part of the functions in gun scope mode.

In order to work properly with different types of guns and scopes, the image in clip-on mode needs to be adjusted to the appropriate position. When clip-on mode interface is displayed, press and hold the Capture button  + Brightness button  at the same time to enter the adjustment page.

18 Laser Rangefinding Operations and Reticle Adjustments

Hybrid supports external laser rangefinding module to realize rangefinding function. The installation of laser rangefinding module is mentioned in **Chapter 7 "Power On and Settings"**. The following is the detailed operation and reticle adjustment of laser rangefinding.

After the laser rangefinding module is connected, the rangefinding reticle is automatically displayed. Press the power button (6) and the image mode button P button (4) to switch between single ranging mode (SGL) and continuous ranging mode (CONT).

In the single ranging mode, press the power button (6), and the target distance information in the lower left corner of the home screen.

In the continuous ranging mode, press the power button (6), and the target distance information will be updated at the lower left corner of the home screen at an interval of 3s.

In the rangefinding mode, press and hold the power button (6) + image mode button P button (4) to call out the adjustment interface of laser rangefinding reticle position, and set X, Y, Center (image center) and Default (laser factory position point). The adjustment range of X and Y is not less than ± 100 pixels (image pixels).

19 Shooting Table Entering and Ballistic Calculation

Hybrid supports the function of entering the shooting table of different gun types by different users. The so-called firing table contains the ballistic information corresponding to different gun types and different bullets. Users can directly record the shooting table information in the device. The operating procedures are as follows:

- Connect the device to the computer with a data cable under the normal working state of the home page after powered on, and open the "U disk" of the computer;
- In "U disk", the sample name in the new folder (the folder name must be "SHOOTING-TABLE") file is "GUN_A_BULLET_a," a indicates the shooting table of gun type A. Similarly, gun type b and gun type c can be uploaded, just modify the yellow part in the sample.

Note: If the unit of distance of the device is m, fill in m in the table; and if the unit is yd, fill in yd in the table.

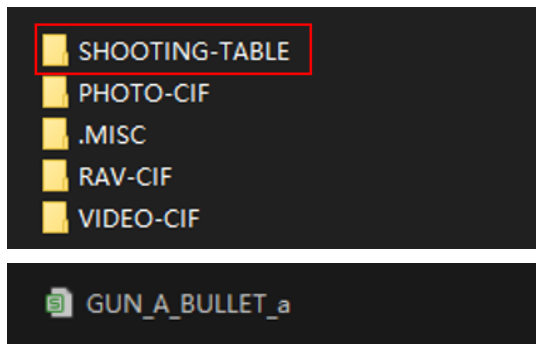

	1	2	3	4	5	6	7	8	9	10	11
m		100	200	300	400	500	600	700	800	900	1000
(mil)		-0.03	0.57	1.42	2.44	3.63	4.98	6.54	8.3	10.76	13.1
m		1100	1200	200	1400	1500	1600	1700	1800	1900	2000
(mil)		16	19.1	23.2	26.7	30	33.5	37.8	42.1	45.8	49.2

- Exit the USB disk mode normally, and power on to check whether the shooting table is changed.

After the ballistic information is entered, the user can obtain a multi-ballistic reticle drawn according to the ballistic information, as shown in the following figure. The aiming position of each inverted triangle represents a reticle point of corresponding distance. If the target distance is known, aiming can be carried out by using the reticle point corresponding to the distance.



- When the ballistic information is entered, but the user is not sure of the target distance, the automatic ballistic calculation function can be used to measure the target distance with an external laser and automatically display the reticle point corresponding to the current target. See the right figure. The red dot position is the automatically generated aiming point position.



20 Wi-Fi

Hybrid has a built-in Wi-Fi module. The device can connect wirelessly to a mobile apparatus (laptop or smartphone) via Wi-Fi.

- In the advanced menu, enable Wi-Fi. For detailed operations, refer to "**Advanced Menu-Wi-Fi**".
- After the Wi-Fi of the scope is enabled, search for the Wi-Fi signal named "HYBRID_HYH50W_XXXX" on the mobile device, of which, XXXX is a 4-bit serial number composed of digits and letters.

- Select the Wi-Fi, enter the password, and connect. The initial password is 12345678;
- After Wi-Fi connection is established, you can control the scope via the app on the mobile device.

Setting Wi-Fi name and password

Hybrid allows you to change the name and password of the device Wi-Fi in the app.

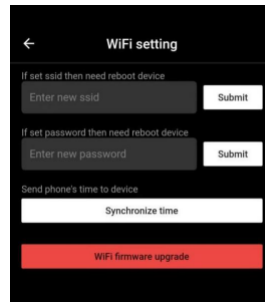

- After the scope is connected to the mobile device, locate the "Settings" icon  in the **InfiRay Outdoor** image screen and tap it to open the "Settings" screen;
- In the text box, enter and submit the new Wi-Fi name (SSID) and password;
- After submitting the change, reset the device to activate the setting.

Caution! After the device is restored to the factory setting, the name and password of the Wi-Fi will also be restored to the default factory setting.

21 Update and InfiRay Outdoor

You can download the user manual of InfiRay Outdoor at our official website (www.infirayoutdoor.com).

You can also test and update the firmware program of the product via the InfiRay Outdoor app or download it on our official website.

About InfiRay Outdoor

- You can download and install the InfiRay Outdoor app on the official website (www.infirayoutdoor.com) or the app store. Alternatively, you can scan the QR code below to download it for free.



- After installing the app, open InfiRay Outdoor application.
- If your device has been connected to a mobile device, please switch on the mobile data in mobile device. After connection, an update prompt will be displayed automatically in the app. Click Now to download the latest version immediately or click Later to update later.
- InfiRay Outdoor can store the last connected device automatically. Therefore, once you have connected with InfiRay Outdoor before, it will automatically detect the update even when the scope is not connected to a phone or laptop. If an update is available and the mobile device accesses the Internet, you can download the update first. Then when the device is connected with the mobile device, the scope will be connected to the mobile device, it will be updated automatically.
- After the update is installed, the device will restart automatically.

22 Technical Inspection

Perform a technical inspection to check the following items each time before you use the device:

- Exterior of the device (no crack on the enclosure).
- Lens and eyepiece (no crack, oil, stain, or other sediments)
- Status of the rechargeable battery (fully charged in advance) and electrical contact (no salinization or oxidation).

23 Maintenance

The maintenance should be carried out at least twice a year and includes the following steps:

- Wipe the surface of metal and plastic parts to clear off dust and dirt by using a cotton cloth. Silicone grease may be used for cleaning process.
- Clean the electric contact and battery slots on the device using a non-greasy organic solvent.
- Check the glass surface of the eyepiece and lens. If necessary, clear off the dust and sand on the lens (it is perfect to use a non-contact method). Use a specialized wiping tool and solvent to clean the optical surfaces.

24 Troubleshooting

The following table lists all problems that are likely to occur during device operation. Check and address problems by referring to this table. If faults not included in this table occur or you cannot fix the fault, return the device to the vendor or supplier for troubleshooting.

Faults	Possible Causes	Solutions
The scope cannot be started.	The battery is out of charge.	Charge the battery.
The device cannot be powered by using an external power supply.	The USB cable is damaged.	Replace the USB cable.
	The external power supply is insufficient.	If necessary, check the external power supply.
Images are unclear, vertical lines are present, or the background is not even.	Calibration is required.	Calibrate the images as instructed in Section IX of the user manual.
Images are too dark.	The display is not bright enough.	Adjusting the display brightness.
Icons are clear but images are blurry.	The lens is not focused.	Rotate the lens focus ring to adjust the focus.
	The inner or outer optical surface of the lens is dusted or iced.	Wipe the outer optical surface by using a soft cotton cloth or leave the scope to dry in a warm and dry environment for more than 4 hours.

Faults	Possible Causes	Solutions
The position of the reticle moves after shooting.	The scope or the fixing clamp is not installed firmly	Check whether the scope is installed firmly. Ensure that the bullet type and caliber you use are consistent with that used for zeroing. If you perform zeroing in summer but use the scope in winter (or vice versa), the zeroing point may move slightly.
The scope cannot focus.	Configuration error.	Set the scope according to the contents as specified in " Power On and Settings ". Check the outer surface of the objective lens and eyepiece, and if necessary, wipe off any dust and frost on it. In cold weather, a special antifogging coating can be applied (such as those used on eyeglasses or car rearview mirrors).
The device cannot connect to a smartphone or computer.	The Wi-Fi password is incorrect.	Enter the correct password.
	There are too many Wi-Fi networks in the range of the device, which may cause interference.	To enable stable network access, you are advised to move the device to an area with a limited number of Wi-Fi networks, or an area without Wi-Fi coverage.

Faults	Possible Causes	Solutions
Wi-Fi signals are lost or interrupted.	The device is beyond Wi-Fi coverage. There is blocking (such as concrete walls) between the device and the receiver.	Move the device to a place where you can receive Wi-Fi signals.
The observed target disappears.	You are observing the target through the glass.	Observe the target directly without the presence of glass.
The image quality is poor or the detection range shortens.	These problems are likely to occur when you use the device in harsh weather (such as snow, rain, and fog).	

25 Legal and Regulatory Information

Wireless transmitter module frequency range:

WLAN: 2.412-2.472GHz (for EU)

Wireless transmitter module power < 20dBm (only for EU)



IRay Technology Co., Ltd. thus declares that the Hybrid series thermal imaging monocular complies with the directives 2014/53/EU and 2011/65/EU. The full text of the EU declaration of conformity as well as additional information are available at: www.infirayoutdoor.com. This device may be operated in all member states of the EU.

FCC Statement

FCC ID: 2AY3N-HYBRID

Labeling requirements

This device complies with part 15 of the FCC Rules. Operation is subject to the following two conditions: (1) This device may not cause harmful interference, and (2) this device must accept any interference received, including interference that may cause undesired operation.

Information to the user

Any Changes or modifications not expressly approved by the party responsible for compliance could void the user's authority to operate the equipment.

Note: The manufacturer is not responsible for any radio or TV interference caused by unauthorized modifications to this equipment. Such modifications could void the user's authority to operate the equipment.

Note: This equipment has been tested and found to comply with the limits for a Class B digital device, pursuant to part 15 of the FCC Rules. These limits are designed to provide reasonable protection against harmful interference in a residential installation. This equipment generates uses and can radiate radio frequency energy and, if not installed and used by the instructions, may cause harmful interference to radiocommunications. However, there is no guarantee that interference will not occur in a particular installation. If this equipment does cause harmful interference to radio or television reception, which can be determined by turning the equipment off and on, the user is encouraged to try to correct the interference by one or more of the following measures:

- Reorient or relocate the receiving antenna.
- Increase the separation between the equipment and receiver.
- Connect the equipment into an outlet on a circuit different from that to which the receiver is connected.
- Consult the dealer or an experienced radio/TV technician for help.

This equipment complies with FCC RF radiation exposure limits set forth for an uncontrolled environment.

Body-worn Operation

This device was tested for typical body-support operations. To comply with RF exposure requirements, a minimum separation distance of 0.5cm must be maintained between the user's body and the handset, including the antenna. Third-party belt-clips, holsters, and similar accessories used by this device should not contain any metallic components. Body accessories that do not meet these requirements may not comply with RF exposure requirements and should be avoided. Use only the supplied or an approved antenna.