

ThermNight



Day & Night Technologies

# CONTENTS

THERMAL NIGHT VISION MULTISPECTRAL SCOPE

General Information .....	01
Product Specifications .....	02
Features .....	04
Controls & Buttons .....	05
Main Functions .....	11
APP Connection .....	28

# ThermNight SERIES

Thermal Night Vision multispectral Scope

## SAFETY INSTRUCTIONS

- ⦿ Do not look directly into the INFRARED (IR) Illuminator to avoid damage to your eyes.
  - ⦿ Switch off the IR Illuminator when not in use. Continuous use of IR light will generate excessive heat. Avoid pointing it towards flammable objects.
  - ⦿ Do not point the device at strong light sources such as the sun, open flames, etc, as this may cause damage to thermal sensor.
  - ⦿ Device operating temperature -4~122°F(-20~50°C).
  - ⦿ Please contact us if there is any malfunctions, please do not attempt to disassemble the scope.
- 

## DESCRIPTION

The ThermNight Series is a multi-spectral scope that uses thermal & night vision technology. It can be used in all weather & lighting conditions. This combination allows for faster detection of targets & provides high-quality digital images for identification.

## PACKAGE CONTENT

- ThermNight Scope
- Eye Cup
- Mount Accessories
- USB Cable
- User Manual

## SPECIFICATIONS

	Model	TNC335R	TNC635R	TNC650R
<b>Physical Specifications</b>	Net Weight	724g / 25.6oz	724g / 25.6oz	755g / 26.6oz
	Dimensions	232x82x78mm / 9.2x3.2x3.0inches	232x82x78mm / 9.2x3.2x3.0inches	245x82x78mm / 9.7x3.2x3.0inches
	Memory	Built-in memory, 64GB	Built-in memory, 64GB	Built-in memory, 64GB
	IP Waterproof	IP67	IP67	IP67
	WIFI / APP	YES (DNT)	YES (DNT)	YES (DNT)
	Operation Distance	5~1100M / 5~1200yds	5~1100M / 5~1200yds	5~1100M / 5~1200yds
	Operating Temperature	-20 ~ 50°C / -4°F ~ 122°F	-20 ~ 50°C / -4°F ~ 122°F	-20 ~ 50°C / -4°F ~ 122°F
	Recoil Proof	800Gs	800Gs	800Gs
<b>Display Specifications</b>	Type	Micro - OLED	Micro - OLED	Micro - OLED
	Display Resolution	1920x1080pixels	1920x1080pixels	1920x1080pixels
	Frame Rate	60Hz	60Hz	60Hz
<b>Battery Powered</b>	Battery Type	21700 Battery (flat top)	21700 Battery (flat top)	21700 Battery (flat top)
	Operating Time	6h	5.5h	5.5h
	External Power Supply	5V - TYPE C USB	5V - TYPE C USB	5V - TYPE C USB

## SPECIFICATIONS

Digital Day/ Night Vision	Model	TNC335R	TNC635R	TNC650R
Sensor Specifications	Resolution	1920x1080pixels	1920x1080pixels	1920x1080pixels
	Frame Rate	60Hz	60Hz	60Hz
	Video Record Resolution	1800x1080pixels	1800x1080pixels	1800x1080pixels
Optical Specifications	Base Magnification	5x	5x	5x
	Digital Magnification	5x, 7.5x, 10x, 12.5x, 15x, 17.5x, 20x	5x, 7.5x, 10x, 12.5x, 15x, 17.5x, 20x	5x, 7.5x, 10x, 12.5x, 15x, 17.5x, 20x
	Eye Relief	65mm	65mm	65mm
	Diopter Adjustment	±3D	±3D	±3D
	IR Wavelength	850 / 940nm	850 / 940nm	850 / 940nm
	IR Rating	Class 3R Eye Safe	Class 3R Eye Safe	Class 3R Eye Safe
	Detection Range	400m	400m	400m

Thermal	Model	TNC335R	TNC635R	TNC650R
Sensor Specifications	Resolution	384x288pixels	640x512pixels	640x512pixels
	Image Sensor	Uncooled infrared image sensor	Uncooled infrared image sensor	Uncooled infrared image sensor
	Frame Rate	50Hz	50Hz	50Hz
	Pixel Size	12x12um	12x12um	12x12um
	NETD	≤18mk @25°C	≤18mk @25°C	≤18mk @25°C
	Objective Lens Focal Length	35mm	35mm	50mm
	Base Magnification	2.5x	1.5x	2.5x
	Digital Magnification	2.5x, 3.75x, 5x, 6.25x, 7.5x, 8.75x, 10x	1.5x, 2.25x, 3x, 3.75x, 4.5x, 5.25x, 6x	2.5x, 3.75x, 5x, 6.25x, 7.5x, 8.75x, 10x



## ■ FEATURES

- Laser rangefinder & built-in ballistic calculator with 3-axis gyroscopic angle detection
- AutoWake
- Ultra HD image quality, Micro-OLED 1920x1080 display
- Picture-in-Picture Function
- One-shot zero for both thermal & digital
- Full-color night mode
- Removeable/replaceable IR Torch
- 64GB internal storage
- 5G Wi-Fi for high-speed data transmission

## PARTS AND CONTROLS

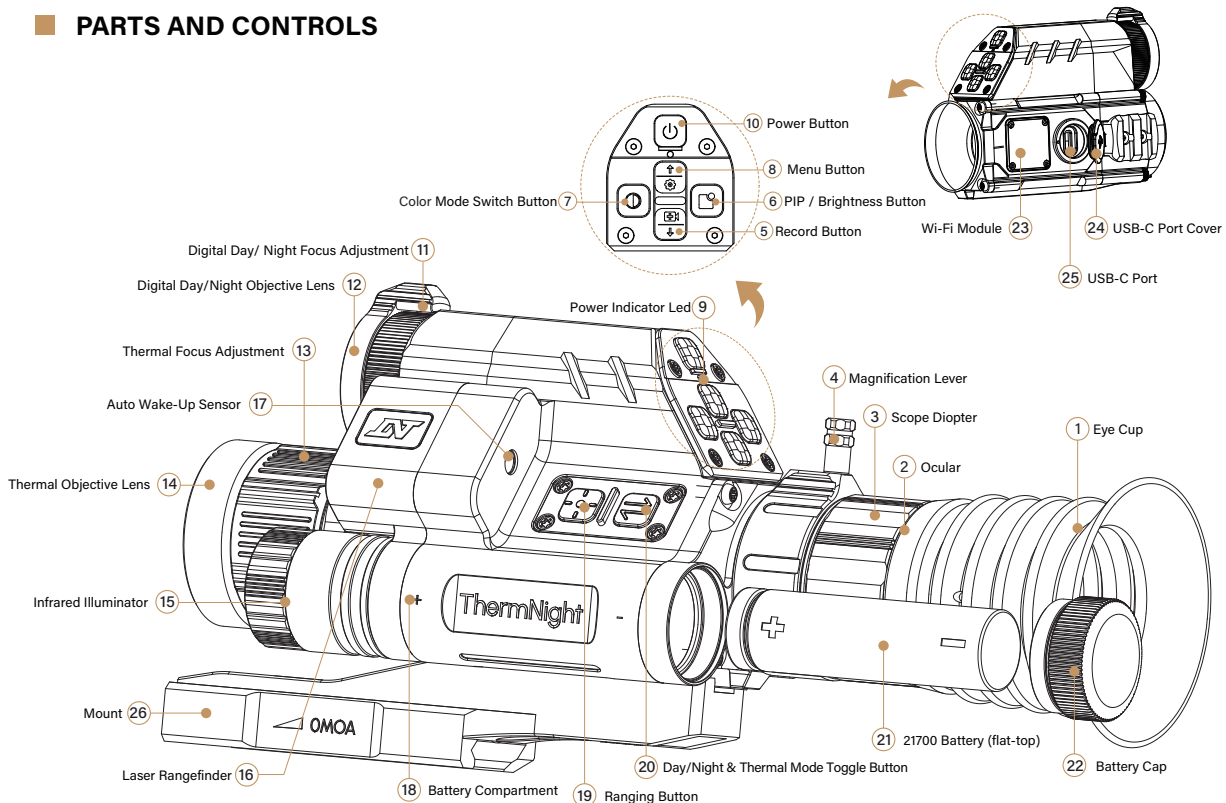



## ■ POWER SUPPLY

This device is powered by an external 21700 battery (flat-top) with up to 6 hours of operation time (when the IR Illuminator is turned off), & can also run off an external power bank via the USB-C cable.

**Note:** External power will not charge the battery in the unit; use the included charging cradle for charging batteries.

### Using Battery

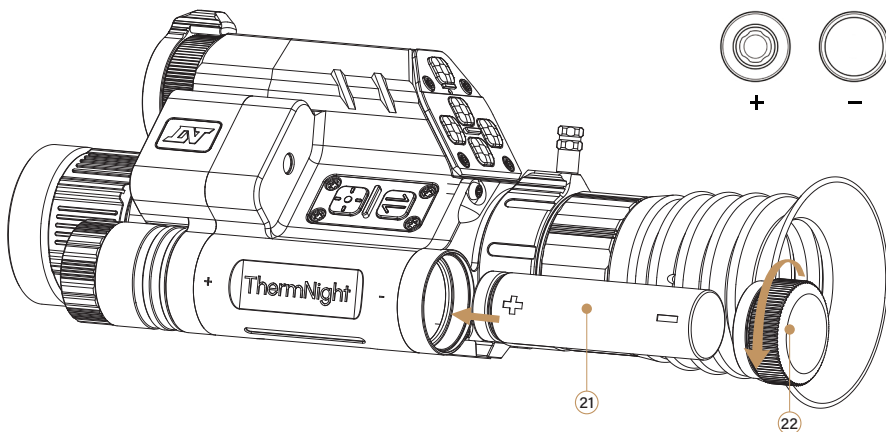

Unscrew the battery cap 22 & remove it to place the "+" level of the battery 21 inward so that the battery cap 22 holds

the battery "-" level, & tighten the battery compartment cover tightly enough that it compresses the gasket



## ■ USB-C DATA TRANSFER

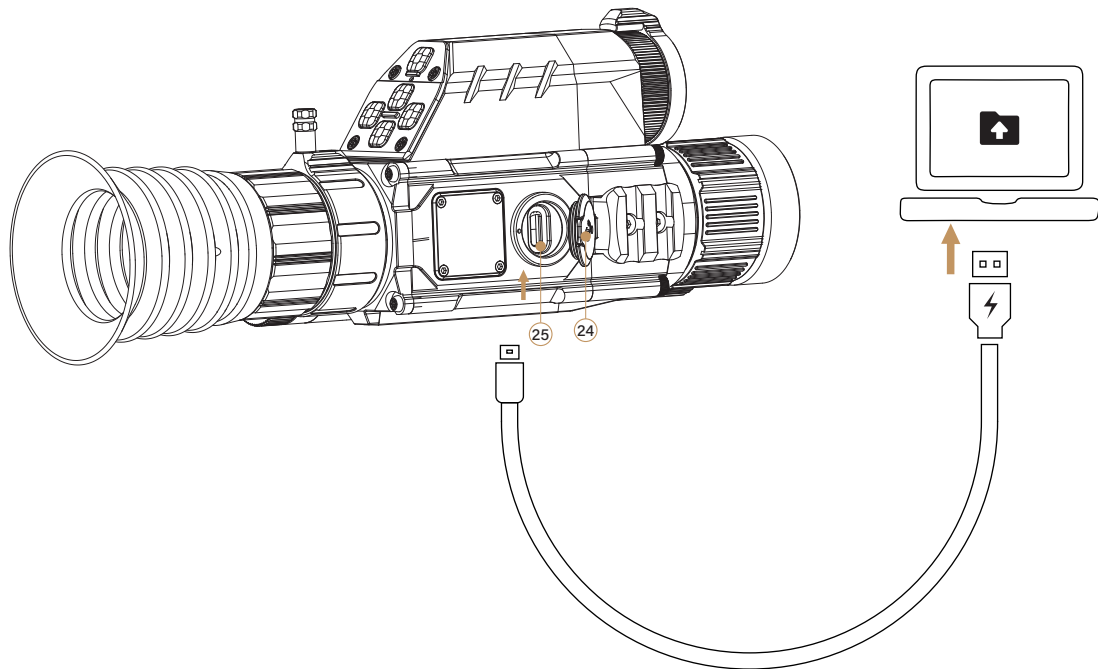

Open the USB-C cover (24) , plug one end of the USB-C cable to the optic's USB-C port (25) , & the other end to the external power supply,

Note: When connected with laptop/PC, the optic will appear as a hard drive. You can copy and download files like you would from any other device.

## REMOVABLE INFRARED ILLUMINATOR (IR TORCH)

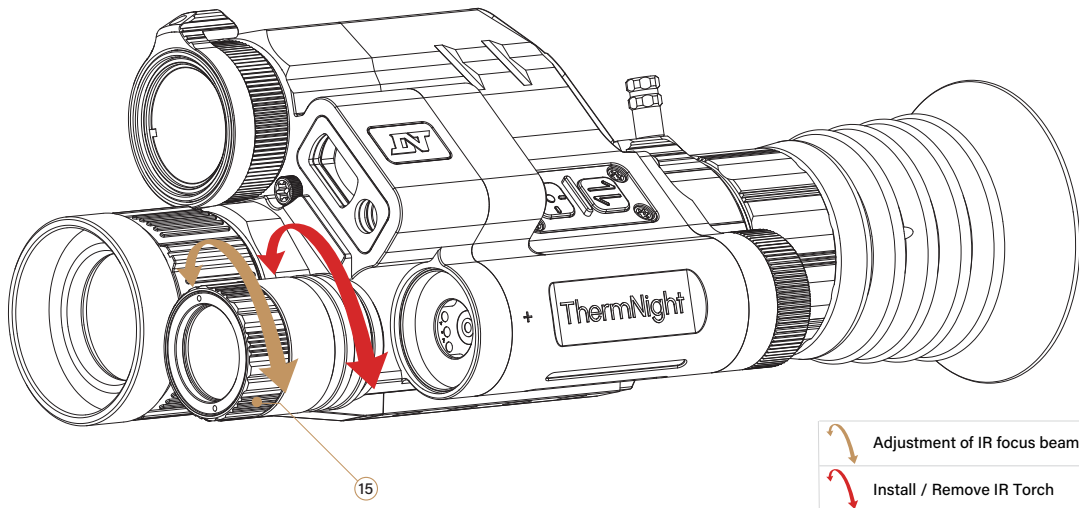

Adjust the infrared light **15** by rotating it to focus the fill light at the longest distance you are likely to shoot. Please note that the infrared fill light **15** can be substituted with models that have a wavelength of 850 nm or 940 nm. Visit [DNTOptics.com](http://DNTOptics.com) for more information on IR wavelengths

## CONTROL DESCRIPTION

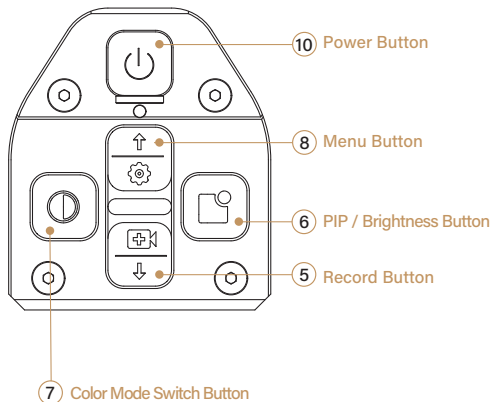

Button	Status	Short Press	Long Press
10	Off	--	On
	On	Standby	Off
	Standby	Wake-up	--
	Reticle Zeroing	Freeze/Continue	--
8	On	Reticle Color Switch / Ranging Reticle Color Switch	Open Settings Interface
	Menu	Move Cursor up	--
	Reticle Zeroing	Move Cursor Up	--
7	Thermal Screen	Change Thermal Palettes	NUC Non-uniformity correction
	Color mode	--	Black/ White Mode
	Black/ White Mode	IR Brightness Adjust	Color Mode
	Menu	Back	--
	Reticle Zeroing	Change Reticle X/Y Value Change Zeroing Profiles	Rapidly Change Reticle X/Y Value
	Date Setting	Move Cursor Left	Save & Exit
	Time Setting	Move Cursor Left	Save & Exit
6	On	Screen Brightness Setting	Turn On/Off PIP
	Menu	Confirm	--
	Reticle Zeroing	Change Reticle X/Y Value Change Zeroing Profiles	Rapidly Change Reticle X/Y Value
	Date Setting	Move Cursor Right	Save & Exit
	Time Setting	Move Cursor Right	Save & Exit
5	On	Start RAV Recording (manual mode)	Stat/End Recording
	Menu	Move Cursor Down	--
	Reticle Zeroing	Move Cursor Down	--

## CONTROL DESCRIPTION

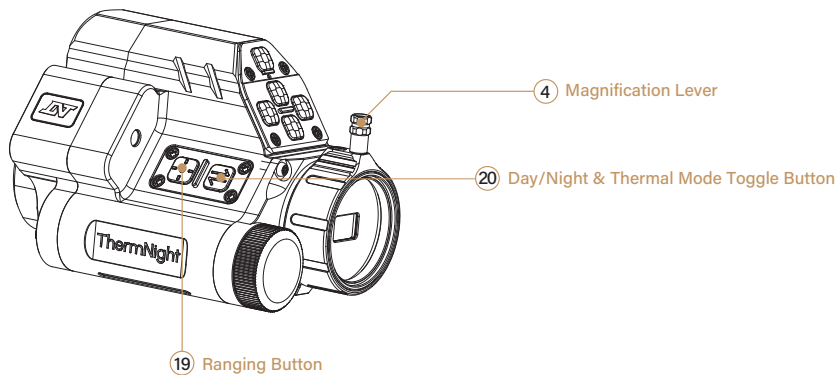

Button	Status	Short Press	Long Press	Rotation
4	On	--	--	Right Turn for Zoom in/ Left Turn for Zoom Out
	Reticle Zeroing	--	--	Right Turn for Zoom in/ Left Turn for Zoom Out
19	Ballistic Calculation Off	Show/Hide ranging icon and distances	Turn Off Ranging	--
	Ballistic Calculation On	Ranging and Ballistic Calculation	Turn Off Ranging	--
20	PIP Off	Switch Digital Day/ Night /Thermal Mode	--	--
	PIP On	Switch between main & PIP Display	Toggle between Day/ NV and Thermal in PIP	--

## ON SCREEN DISPLAY

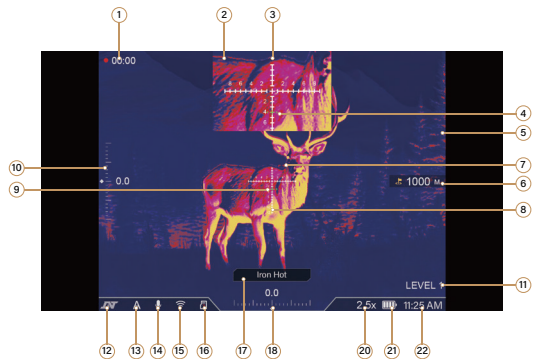

- ① Recording Indication: Recording Timer Indicates That the Device Is Currently Recording.
- ② Picture In Picture Window (Night Vision or Thermal)
- ③ PIP Reticle
- ④ PIP Ballistic Calculation Point of Aim
- ⑤ Main Display
- ⑥ Ranging Distance
- ⑦ Ranging Reticle
- ⑧ Main Display Reticle

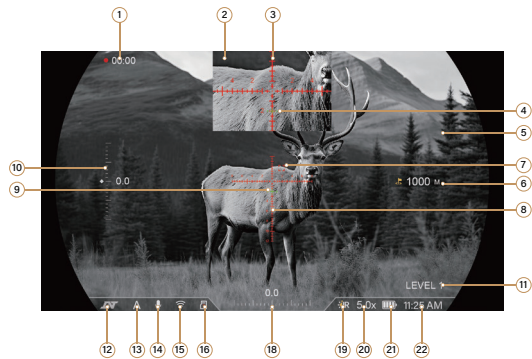

- ⑨ Main Display Point Of AIM
- ⑩ Gyroscope Vertical Direction Angle
- ⑪ Current Screen Brightness Level
- ⑫ DNT LOGO
- ⑬ Ballistic Profiles Info
- ⑭ Mic(It Only Shows When Recording Audio is on)
- ⑮ Wi-Fi(It Only Shows When Wi-Fi is on)
- ⑯ Built-In Memory(It Only Shows When Memory Error Occurs)

## ON SCREEN DISPLAY

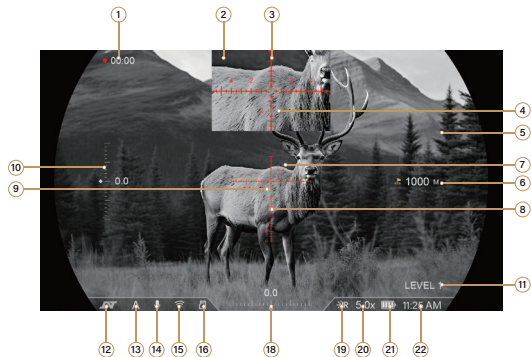
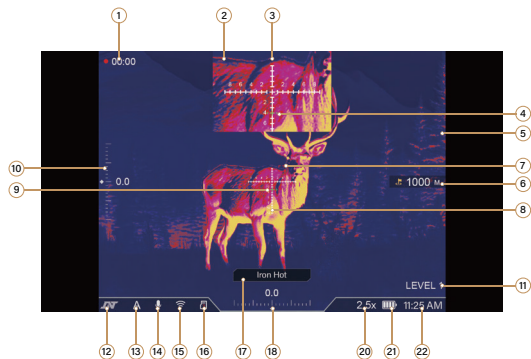

17 Current Thermal Palette

18 Gyroscope Horizontal Direction Angle

19 Current Icon Indicates Night Mode, If the Icon is Not Displayed, It is in Day Mode

	Night Mode, IR Off
	IR On Level 1(The Sun Light Bar Indicates IR Level)
	IR On Level 2
	IR On Level 3
	IR On Level 4
	IR On Level 5
	IR On Auto Mode (The Sun Light Bar Indicates IR Level)

20 Current Magnification

21 Battery Level

Icon	Status	Battery Status
	Low Battery	0% ~ 10%
	1 bar	10% ~ 20%
	2 bars	20% ~ 50%
	3 bars	50% ~ 80%
	4 bars	80% ~ 100%
	USB Powered	Connected to type C

22 Current Time

## MENU LIST

Long press the **Menu Button** for 2 seconds to enter Settings; Short press **Menu** & **Record Buttons** to navigate Up & Down.

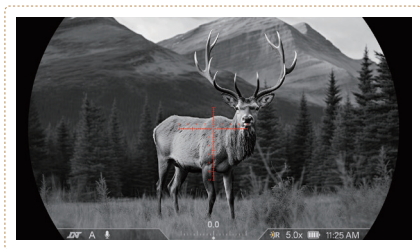

(main screen)



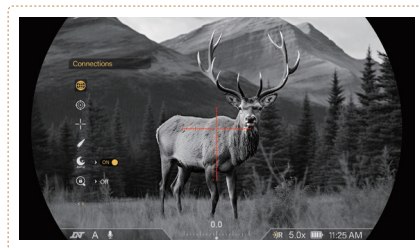

Long Press 2s

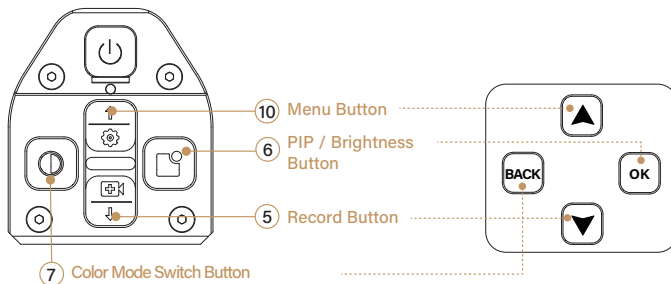

(menu)



## MENU LIST

Long press the **Menu Button**  for 2 seconds to enter Settings; Short press **Menu**  & **Record Buttons**  to navigate Up & Down.

Icon	Description
	<b>【Connections】</b> Wi-Fi Setting
	<b>【Zeroing】</b> Zeroing
	<b>【Reticle Settings】</b> Digital Reticles: 1-FFP / 2-FFP / 3-SFP / 4-SFP / 5-SFP / 6-SFP / 7-SFP / 8-SFP / Hide Thermal Reticles: 1-FFP / 2-FFP / 3-SFP / 4-SFP / 5-SFP / 6-SFP / 7-SFP / 8-SFP / Hide Digital Reticle Colors: Red / Green / Yellow / Black / White Thermal Reticle Colors: Red / Green / Yellow / Black / White
	<b>【Ballistic Calculator】</b> Turn ON / OFF Ballistic Calculation Ballistic Data Settings Aiming Method: Holdover / Dial In Display Ballistics: MRAD / MOA / cm / inches / Off
	<b>【Auto Wake-Up】</b> ON / OFF
	<b>【Thermal Zoom Lock】</b> Off / 2.5x / 1x (1.5x / 1x For TNC635R)
	<b>【LRF Settings】</b> Ranging Modes: Continuous Ranging, Single Pulse Ranging, Timed Ranging 3s / 5s / 10s Ranging Units: Meter / Yard
	<b>【PIP Settings】</b> Off / Left / Center / Right
	<b>【Recoil Activated Recording】</b> Auto Mode / Manual Mode / Off



## MENU LIST

Long press the **Menu Button** for 2 seconds to enter Settings; Short press **Menu** & **Record Buttons** to navigate Up & Down.

Icon	Description
	<b>【Digital/Thermal Toggle】</b> Select between Thermal Mode, Digital Day/Night Mode and Dual Mode (PIP)
	<b>【Digital Image Settings】</b> Select between Natural Mode and Color Enhancement
	<b>【Thermal Image Settings】</b> Thermal Imaging Mode: Natural / Enhanced / Highlight Palettes: White Hot / Black Hot / Red Hot / Iron Hot Image Contrast: 1-5 Image Brightness: 1-5 Hotspot Tracking: ON / OFF
	<b>【Function Settings】</b> Defective Pixel Repair Auto Power Off: Auto Off shutdown time after sleep: 10 / 20 / 30minutes Loop Recording: Off / 1 / 3 / 5minutes Audio Recording: ON / OFF Gyroscope: ON / OFF / Calibration IR Torch Type: IR-LED / IR-V Screen Brightness: 1-5
	<b>【System Settings】</b> Date / Time Language Setting: English / Français / Español / Deutsch / Italiano Format Restore Default Settings Available Storage Version

## MAIN FUNCTION

### Zeroing The Reticle

Long press the **Menu Button** for 2 seconds to open Settings, short press the **Record Button** down to "Zeroing" , and press the **PIP Button** to select.

Short press the **Power Button** to freeze/unfreeze the current image, or short press the **Record Button** to toggle "Freeze" to "On!" Short press the **PIP Button** to confirm freeze/unfreeze the current image.

- Short press the **Menu Button** to move the cursor up. Short press the **Record Button** to move the cursor down
- Short press to adjust the current value by 1, press & hold to continuously increase the current value. will increase the value, will decrease the value
- Select "Save" & press the **PIP Button** to confirm, save & exit
- Select "Return", & short press the **PIP Button** to confirm, to exit without saving

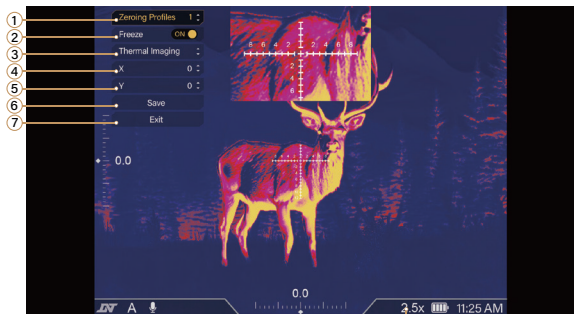
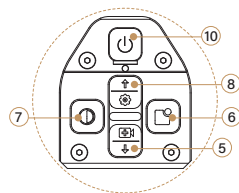

- Zeroing Profiles 1: Current zeroing Profile info. Total 10 Profiles
- Freeze: Freeze / Unfreeze image
- Digital/Thermal Imaging: Which mode you are currently zeroing
- X=0: The horizontal position of the reticle (Left & Right)
- Y=0: The vertical position of the reticle (Up & Down)
- Save: Save & Exit
- Exit: Exit without Saving
- 5x(2.5x): Magnification Setting

8

## Thermal Zeroing

Switch the display to Thermal Imaging, & follow the same zeroing procedures listed above.

Picture-in-Picture allows for easier spotting of your point of impact, allowing you to zero your optic more quickly.

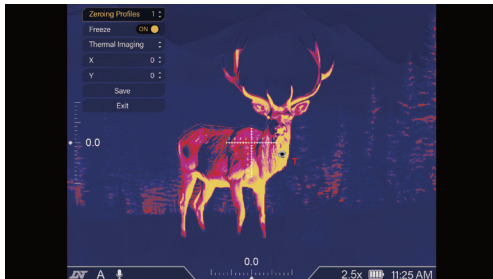

Figure (1)



Figure (2)

## Example of Day/Night Calibration

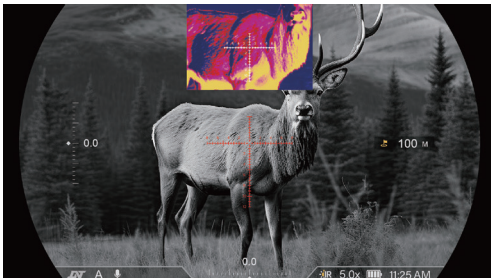

Figure (1)

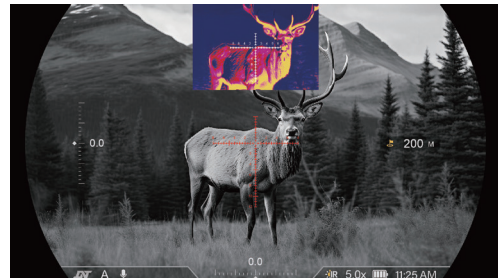

Figure (2)

**NOTE:** Point of Aim/Point of Impact will be different for day/night & thermal, so they each need to be zeroed separately.



(Zeroing at 100m )



(Aim the target at 200m)

## Thermal Zoom Lock (TNC335R for Example)

Make sure you are in dual mode (Digital/ Thermal), Long press the **Menu Button**  then short press the **Record Button**  and move cursor to thermal lock option, short press **PIP Button**  and select your thermal lock.

### Thermal Lock 2.5x

- When the thermal lock is set to 2.5x, thermal magnification will remain at 2.5x on the main screen or PIP. The digital day/night mode magnification will remain unaffected and can be zoomed in or out. (Figure 1 & 2)

### Thermal Lock 1x

- When the thermal lock is set to 1x, the thermal PIP window will be 1X, but the main screen will remain locked at 2.5x. The digital day/night mode magnification will remain unaffected and can be zoomed in or out. (Figure 2 & 3)

When thermal lock is turned off, both channels can be magnified as usual.

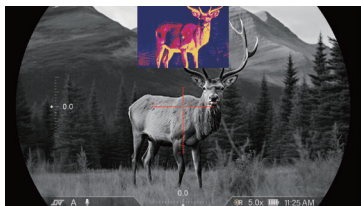

Figure (1)

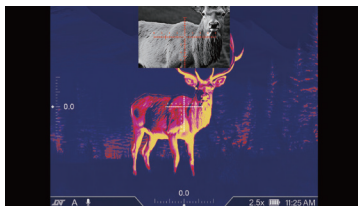

Figure (2)

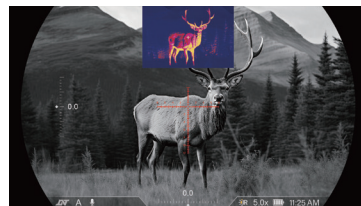





Figure (3)

## AutoWake

Press & hold the **Menu Button**  for 2 seconds, & select "Auto Wake-Up". Once activated, the device will automatically enter sleep mode when the shooter's eye leaves the objective lens. Once the shooter is back in position, the device will automatically wake up. (In sleep mode, long press the **Menu Button**  for 2 seconds to quickly turn off this function).

## Dual Mode

In Dual Mode, a short press of the **Day/ Night & Thermal Mode Toggle Button**  will toggle the displays for the main screen & PIP window. See Figure (1), the main screen shows thermal while the PIP window displays night vision. Pressing the **Day/ Night & Thermal Mode Toggle Button**  will flip the displays Figure (2) so the main screen shows the digital night mode & the PIP window shows the thermal.

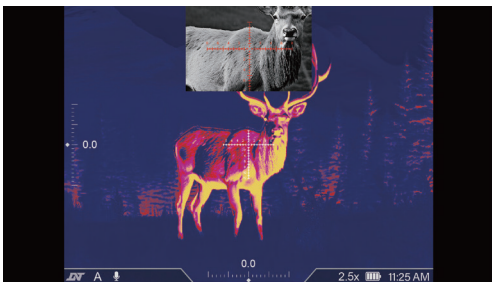

Figure (1)

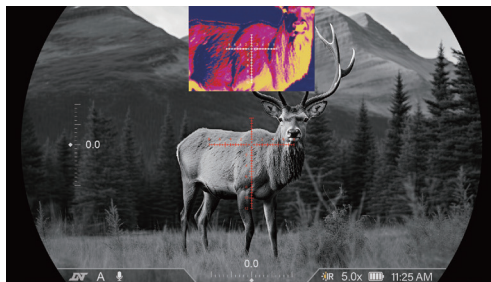

Figure (2)

## Day/ Night Vision Mode & Thermal Mode

The PIP window magnification defaults to 2x the main display.

**NOTE:** In this mode, short pressing the **Day/ Night & Thermal Mode Toggle Button**  will switch from Figure (1) to Figure (2)

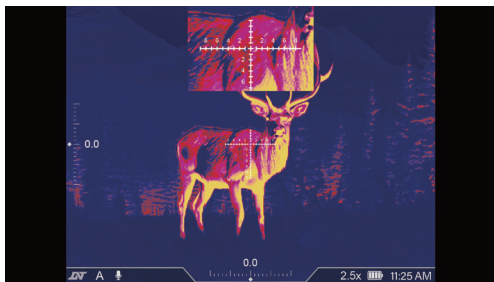

Figure (1)

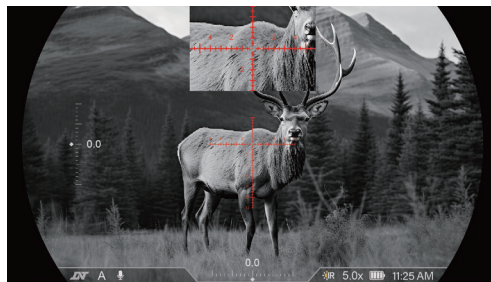
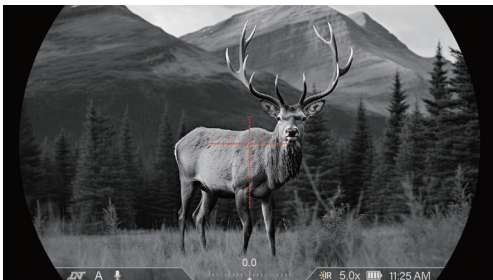

Figure (2)

## Range Finding

### Continuous Ranging

- Long press the **Menu Button** for 2 seconds to open Settings, short press the **Record Button** to move the cursor to "Ranging Method", click the **PIP Button** to select "Continuous Ranging"
- Short press the **Ranging Button** to turn on range finding. The screen will display the range-finding icon & target distance. The target range will continuously update in real time as your target distance changes
- Long press the **Ranging Button** for 1.5 seconds to turn off the ranging function



( First short press Range Finding button)

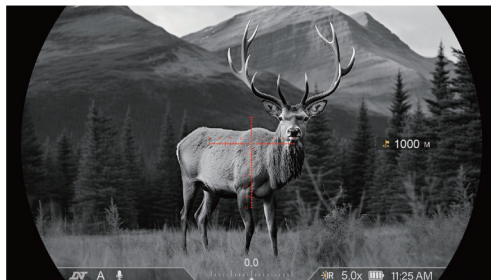







(Short press or long press range finding button for 1.5 seconds)







## Range Finding

### Single Pulse Ranging

- Long press the **Menu Button**  for 2 seconds to open Settings, short press the **Record Button**  to move the cursor to "Ranging Method", click the **PIP Button**  to select, move the cursor to "Ranging Method", & select "Single Pulse Ranging"
- Short press the **Ranging Button**  : turn on the ranging function, and display the ranging icon & target distance. Press the **Ranging Button**  again to measure distance again
- Single point ranging will automatically turn off by long pressing the **Ranging Button**  for 1.5 seconds or if unused for 20 seconds

### Timed Ranging

- Long press the **Menu Button**  for 2 seconds to open Settings, short press the **Record Button**  to move the cursor to "Ranging Method", click the **PIP Button**  to select, move the cursor to "Ranging Method", & select "Timed Ranging" for 5, 10, or 15 seconds
- Short press the **Ranging Button**  : turn on the range-finding function, and display the ranging icon & target distance. The device will continue to display target ranges for the duration selected
- Timed Ranging will turn off with a press of the **Ranging Button** 



## Built-In Ballistic Calculator

Long press the **Menu Button**  for 2 seconds to open Settings, navigate to the Ballistic Calculator select, and toggle it "ON".

## Ballistic Data Settings



After opening Ballistic Calculator from the Settings menu, select "Ballistic Data Settings" and it will open the following screen:







Figure (1)



Figure (2)

Press the **Record Button**  or press the **Menu Button**  to adjust the value

Short press the **PIP Button**  or short press **Color Mode Switch Button**  to move the left or right cursor & press **PIP Button**  or press the **Color Mode Switch Button**  to save & exit the screen

## Ballistic Calculation—APP WiFi Connection

You can upload ballistic data from the DNT app to the device once they have been paired via WiFi.

NOTE:(APP installation & connection instructions on page 28)

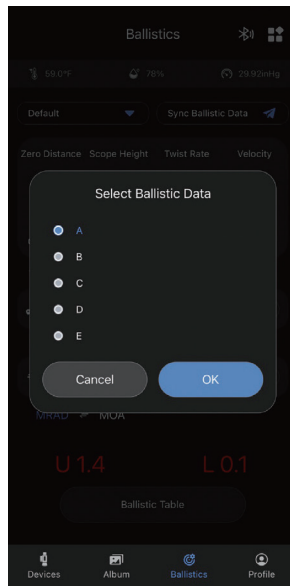
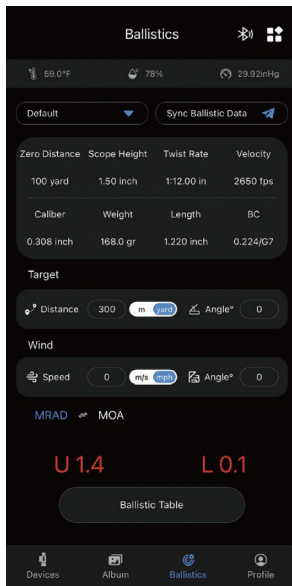

## Aiming Method - Holdover

Long press the **Menu Button**  for 2 seconds to open Settings, short press the **Record Button**  to move the cursor to "Aiming Method", click the **PIP Button**  to select "Holdover".

- A short press of the ranging button will display the ranging icon & the measured distance
- A second short press of the ranging button will display the holdover reticle for the correct point of impact
- A third short press of the ranging button will clear the holdover reticle
- Long press the ranging button for 1.5 seconds will turn off the ranging function. Ranging icon & distance disappear

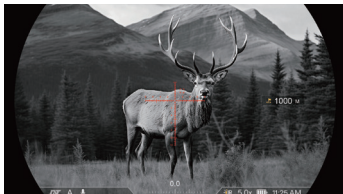

(First short press Ranging Button)

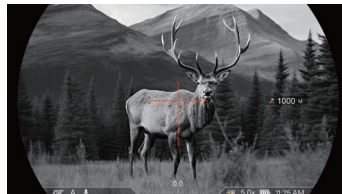

(Second short press Ranging Button)

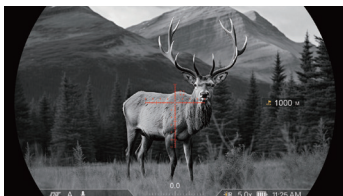

(Third short press Ranging Button)

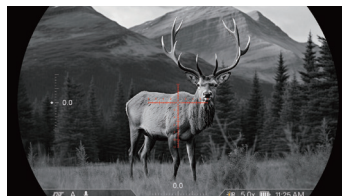

(Long press Ranging Button for 1.5 seconds)

## Aiming Method – Dial In

Long press the **Menu Button**  for 2 seconds to open Settings, short press the **Record Button**  to move the cursor to "Aiming Method", click the **PIP Button**  to select "Dial In"

- A short press of the ranging button will turn on the ranging function, display the ranging icon & measured distance
- A second short press of the ranging button will display the ranging distance & re-zero the main reticle to the correct point-of-aim/point-of-impact
- A third short press of the ranging button will return the reticle to the shooter's initial zero
- Long press the ranging button for 1.5 seconds will turn off the ranging function, & the ranging icon & distance

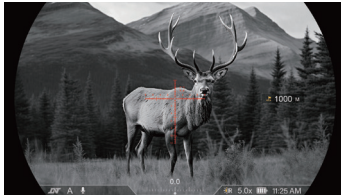

(First short press Ranging Button)



(Second short press Ranging Button)

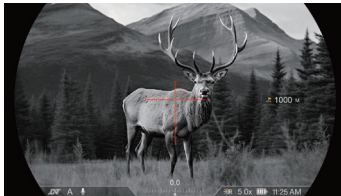

(Third short press Ranging Button)

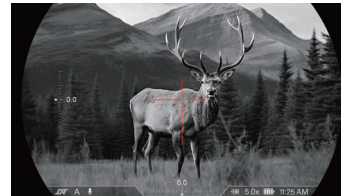

(Long press Ranging Button for 1.5 seconds)

## Dual Mode – Ballistic Calculation

- Zero Digital Night Vision and Thermal at a distance of 100 meters, as shown in Figure (1)
- Aim at your target, as shown in Figure (2)
- Perform Ballistic Calculation and confirm the point of aim for Digital Night Vision and Thermal are the same, as shown in Figure (3)

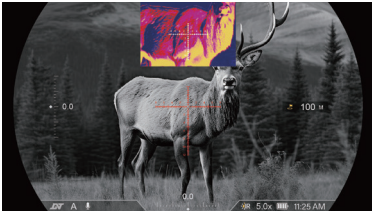

Figure 1 (100m Zero)

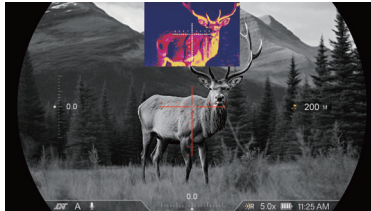

Figure 2 (200m target w. reticle rezeroed)

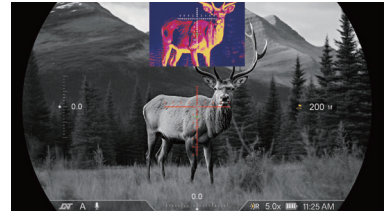

Figure 3 (Thermal returns to previous magnification)

## ■ APP USER MENU

### Installation DNT APP

Download the DNT mobile app via the app store, or use the QR code below.







Android



iOS

## Connecting App to Device

- Long press the **Menu Button**  for 2 seconds to open Settings, short press the **Record Button**  to move the cursor to "Network Settings", click the **PIP Button**  and select "Wi-Fi"
- Press the **PIP Button**  to toggle Wi-Fi to "On". This will display the Wi-Fi name & password of the device (Figure 1)
- Open your phone's Wi-Fi settings, select the device's Wi-Fi name, enter the password, & then click connect

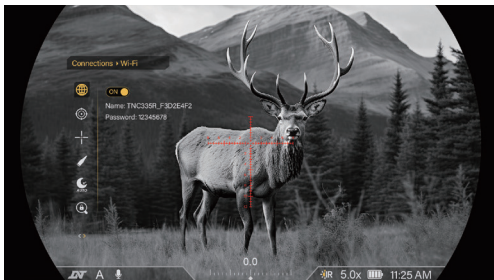
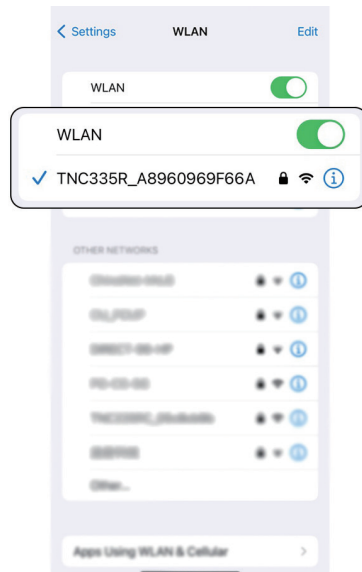

Figure (1)





## Connecting App to Device

- To add a device, open the DNT app & click "Add Device". Select "ThermNight Multispectral," find TNC335R/ TNC635R / TNC650R, & click Add
- After adding the device successfully, it is now connected

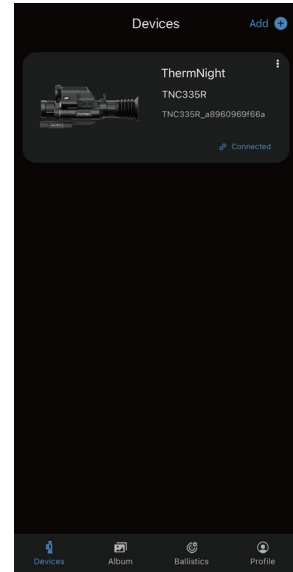
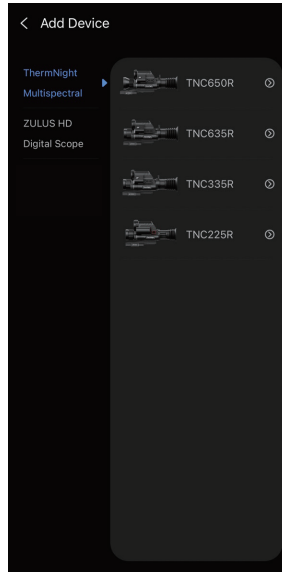

## ■ FCC WARNING

This device complies with part 15 of the FCC Rules. Operation is subject to the following two conditions: (1) this device may not cause harmful interference, and (2) this device must accept any interference received, including interference that may cause undesired operation.

Any changes or modifications not expressly approved by the party responsible for compliance could void the user's authority to operate the equipment.

NOTE: This equipment has been tested and found to comply with the limits for a Class B digital device, pursuant to Part 15 of the FCC Rules. These limits are designed to provide reasonable protection against harmful interference in a residential installation. This equipment generates, uses and can radiate radio frequency energy and, if not installed and used in accordance with the instructions, may cause harmful interference to radio communications. However, there is no guarantee that interference will not occur in a particular installation.

If this equipment does cause harmful interference to radio or television reception, which can be determined by turning the equipment off and on, the user is encouraged to try to correct the interference by one or more of the following measures:

- Reorient or relocate the receiving antenna.
- Increase the separation between the equipment and receiver.
- Connect the equipment into an outlet on a circuit different from that to which the receiver is connected.
- Consult the dealer or an experienced radio/TV technician for help. To maintain compliance with FCC's RF Exposure guidelines, This equipment should be installed and operated with minimum distance between 20cm the radiator your body: Use only the supplied antenna.



[www.dntoptics.com](http://www.dntoptics.com)