



IRay Technology Co., Ltd.

Tel: 0086-400-999-3800

Email: infiRayoutdoor@infiRay.com

Web: www.infiRayoutdoor.com

Add: 11th Guiyang Street, YEDA, Yantai, P.R. China



User Manual

V3.0

AFFO Series | Thermal Imaging Monocular

AP09/AP13/AL19/AL25

IMPORTANT SAFETY INFORMATION

Environmental influences

WARNING! Never point the lens of the device directly at intense heat sources such as the sun or laser equipment. The objective lens and eyepiece can function as a burning glass and damage the interior components. The warranty does not cover damage caused by improper operation.

Ergonomics notes

Caution: Take breaks after longer periods of use to avoid wrist pain.

Risk of swallowing

Caution: Do not place this device in the hands of small children. Incorrect handling can cause small parts to come loose which may be swallowed.

Safety instructions for use

- Handle the device with care: rough handling may damage the internal battery.
- Do not expose the device to fire or high temperatures.
- Do not disassemble the device to access the battery. The battery is not

meant to be replaced by the end user.

- Only use the battery charger included in the delivery package.
- Only charge the device at temperatures ranging between 0°C and 40°C.
- The battery capacity decreases when operated in a cold ambient temperature. This is not a fault and occurs for technical reasons.
- Temperature exceeding this range will affect the service life of the product.
- Do not store the device for long periods at temperatures below 20°C or above 50°C. This permanently reduces the capacity of the battery.
- Always store the device in a dry, well-ventilated space.
- If the device has been damaged or the battery is defective, send the device to our after-sales service for repair.
- Before using this product in an environment with water, ensure that the Type-C interface rubber cap on the bottom of the thermal imaging monocular is tightly covered.

Safety instructions for the power supply unit

- Check the power supply unit, cable and adapter for visible damage before use.
- Do not use any defective parts. Defective components must be replaced.

- Do not use the power supply unit in wet or humid environments.
- Only use the original cable provided with the battery charger.
- Do not make any technical modifications.

For further information and safety instructions, please refer to the Operation Manual provided. This is also available on our website in the download center: www.infirayoutdoor.com.

Disposal of batteries



In the European Union, this symbol indicates that the battery used in this product may not be disposed of in domestic waste and must be collected for disposal separately. When returning used batteries, please use a collection system that may exist in your country.

The materials and substances in the batteries may have a detrimental impact on health and the environment.

By depositing empty batteries at a recycling facility, you are contributing to the protection, maintenance and improvement of the quality of our environment.

Please only return discharged batteries.

The battery used does not contain mercury, cadmium or lead in quantities

exceeding

the limits defined in Directive 2006/66/EC.

User information on the disposal of electrical and electronic devices (private households)



The WEEE symbol on products and/or accompanying documents indicates that used electrical and electronic products must not be mixed with ordinary household waste. For proper treatment, recovery and recycling, take these products to the appropriate collection points where they will be accepted without charge. In some

countries, it may also be possible to return these products to your local retailer when you purchase a corresponding new product. The proper disposal of this product serves to protect the environment and prevents possible harmful effects on human beings and their surroundings, which may arise as a result of incorrect handling of waste.

More detailed information on your nearest collection point is available from your local authority. In accordance with state legislation, penalties may be imposed for the improper disposal of this type of waste.

For business customers within the European Union

Please contact your dealer or supplier regarding the disposal of electrical and electronic devices. He will provide you with further information.

Information on disposal in other countries outside of the European Union

This symbol is only applicable in the European Union. Please contact your local authority or dealer if you wish to dispose of this product and ask for a disposal option.

Intended use

The device is intended for displaying heat signatures during nature observation, remote hunting observations and for civil use. This device is not a toy for children.

Use the device only as described in this operating manual. The manufacturer and the dealer accept no liability for damages which arise due to non-intended or incorrect use.

Function test

- Before use, please ensure that your device has no visible damage.
- Test to see if the device displays a clear, undisturbed image.
- Check that the settings for the device are correct. See the notes in the

section Operation.

Installing/removing the battery

The AFFO series thermal imaging monocular is equipped with a battery. It cannot be removed.

Observation with and without glasses

Thanks to the flexible eyeshade, the Tube series can be used with or without glasses. It offers a full field of view in both cases.

1 Specifications

Model	AP09	AP13	AL19	AL25
Detector Specifications				
Type	Uncooled Vox			
Resolution	256 × 192		384 × 288	
Pixel Size, μm	12			
NETD, mk	≤ 40			
Frame Rate, Hz	25		50	
Optical Specifications				
Objective Lens, mm	9	13	19	25
Field of View, °	19.4×12.2	13.5×8.4	13.8×8.7	10.5×6.6
Linear Field of View(H×V), m at 100m	34.1×21.3	23.6×14.8	24.3×15.2	18.4×11.5
Magnification, ×	1.3	2.0	2.0	2.5
Digital Zoom, ×	1 / 2		1 / 2 / 4	
Diopter	-7 ~ +2			
Eye Relief, mm	20			
Exit pupil Diameter, mm	5			
Detection Range, m (Target size: 1.7m×0.5m, P(n)=99%)	460	670	980	1300
Display Specifications				
Type	AMOLED			

Resolution	640 × 400	
Battery Power Supply		
Battery Type / Capacity / Output Voltage	Built-in li-ion battery/3.6Ah/3.6V	
Max. Operating Time (t=22 °C), h*	9.5	7.5
External Power Supply	5V (Type C)	
Physical Specifications		
Ingress Protection Rating	IP67	
Memory Capacity, GB	8	
Wi-Fi / APP	Support (InfiRay outdoor)	
Operating Temperature, °C	-20 ~ +50	
Weight, g	< 340	< 350
Dimension, mm	160 × 60 × 60	169 × 60 × 60

* Actual operation time depends on the density of Wi-Fi use and the built-in video recorder.

➤ Improvements may be made to the design and software of this product to enhance its features without prior notice to the customer.

2 Package Contents

- AFFO series thermal imaging monocular
- Neck strap
- Wrist strap
- Drawstring bag
- Type-C data cable
- Lens cleaning cloth
- Quick Start Guide

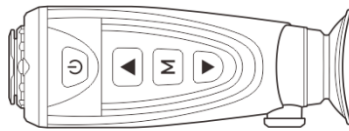

AFFO Series



Quick Start Guide

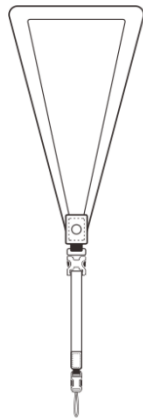

Neck Strap

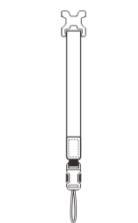

Wrist Strap



USB Cable



Lens Cloth

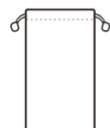

Drawstring Bag

3 Description

The AFFO series thermal imaging monocular is for outdoor use. It can be used in the day or night, or in harsh weather (such as rain, snow, fog, and haze) without being affected by strong light. It requires no external light source. Even targets hidden behind obstacles (such as branches, grass, and shrubs) can be observed. The AFFO series thermal imaging monocular is light and easy to carry, small in size, suitable for single-hand operation, comfortable in use, and rich in functions. It can be widely used for hunting, searching, and locating in various outdoor conditions.

4 Features



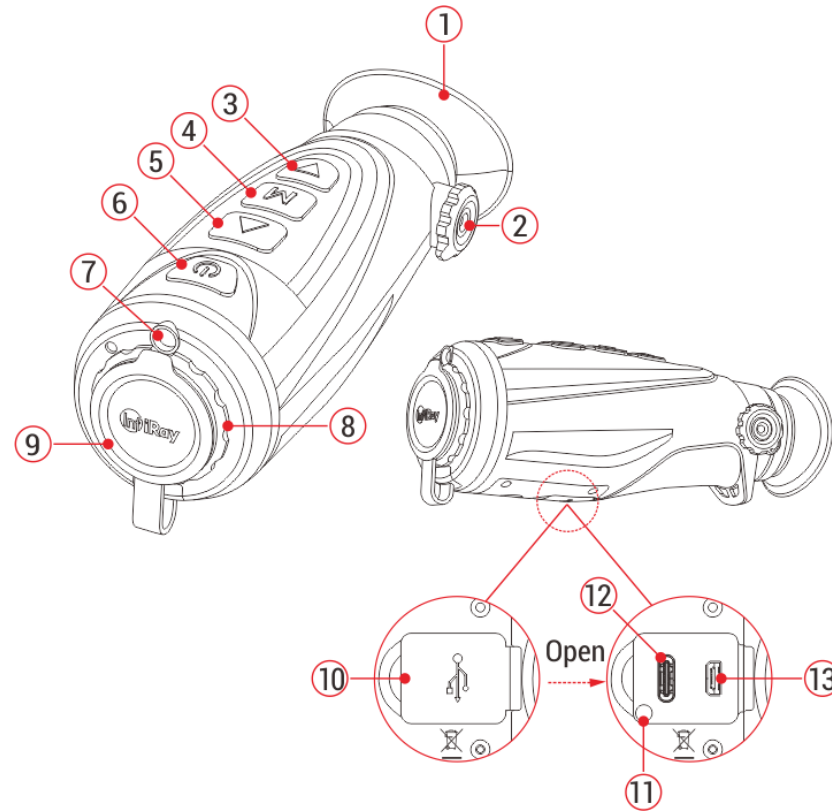

- 12 μ m self-developed detector
- High image quality
- Lightweight and compact
- Stadiametric rangefinder
- Long detection distance
- Built-in memory card, supporting photo taking and video recording
- Built-in Wi-Fi module, supporting app connection

5 Units and Controls

1. Eyeshade
2. Diopter adjustment
3. Down button
4. Menu (M) button
5. Up button
6. Power button
7. LED light
8. Objective lens
9. Lens cover
10. USB rubber cap
11. Power indicator
12. Type C port
13. Micro HDMI port





6 Button Descriptions

Button	Current Status	Press	Press and Hold
Power button 	Powered off	—	Power on the device
	Home screen	Enter the standby mode (the display is off, and the main chip enters the standby mode)	Power off the device
	Standby mode	Wake up the device	—
	Menu interface	Return to the home screen without saving	Power off the device
Up button 	Home screen	Switch the image mode	—
	Menu interface	Scroll up the menu option	—
	Powered off	—	Keep pressing to turn on the LED indicator and release the button to turn off the LED indicator
Menu button 	Home screen	Digital zoom	Enter the menu interface
	Menu interface	Enter the submenu / Confirm the selection	Save and return to the home screen
Down button 	Home screen	Take a photo	Start the video recording
	Menu interface	Scroll down the menu option	—
	Video recording	Take a photo	Stop and save the video recording
Up + M buttons	Home screen	—	Turn on/off the stadiametric rangefinder function
Up + Down buttons	Home screen	—	Turn on/off hotspot tracking
M + Down buttons	Home screen	—	Calibration the sensor

7 Charging

The AFFO series is supplied with a built-in rechargeable Li-ion battery pack, which allows operation up to 9.5 hours. **When using the device for the first time, please fully charge it first.**

- Open the USB rubber cap (10) on the bottom of the device.
- Connect the Type C plug of the data cable to the Type C port (12) on the device.
- Connect another port of the data cable to the power adapter.
- Insert the plug of the adapter to the 110-240V socket.
- When the device is charging, the power indicator (11) next to the Type C port (12) is red. The power indicator (11) is on only in the charging status. When the power indicator (11) turns green, the device is fully charged. When the power indicator (11) blinks alternately red and green, it indicates that the battery is not charged or the temperature is too high or too low.
- When charging, a lightning icon  will appear inside the battery icon on the display. The lightning icon will not disappear until the data cable is removed or the power is cut off.
- Charging is finished when the interior of the battery icon on the display

is completely green  .

- During using, when the battery icon turns red , this means the power level is low, please charge the device in time to avoid the data loss.

Safety instructions for battery

- The rated voltage of the product is 5V. Please charge the device promptly when the battery is low so that the service life of the thermal imaging monocular will not reduce due to battery over-discharge.
- Don't charge the device instantly while bring the battery from cold environment to warm environment. Charging after 30-40 mins.
- Charge the device at a temperature from 0°C to +40°C, otherwise the battery life will be reduced significantly.
- Never use a damaged or modified charger.
- Don't leave battery unattended when charging. Don't leave the device with a charger connected to the mains longer than over 24 hours after full charge.
- Do not expose the battery to high temperature or to a naked flame.
- Don't connect external device with a current consumption that exceed permitted levels.

- The battery is short circuit protected. However, any situation that may cause short-circuiting should be avoided.
- Don't dismantle the battery from the device.
- The battery capacity may decrease when using the battery in negative temperature, that is normal, not a defect.
- Avoid using the battery at the temperature above the temperature shown in the table, this may decrease the battery's life.
- If the thermal imaging monocular is not used for a long time, recharge the device every 2 months at least and charge to 40%-50% power, then store the device in a dry and ventilated environment.
- Partial charging the battery is necessary if the battery is planned to be idled for long time. Avoid fully charged or discharged.
- Keep the battery out of the reach of children.

8 LED Light

The AFFO series is equipped with the LED light (7). You can quickly turn on/off the LED light (7) only when the AFFO is turned off

- When the device is powered off, keep pressing down the **Up (5)** button to turn on the LED light, and release the **Up (5)** button to turn off the LED

light.

- Please note that when the device is turned on, the LED light is unavailable.

9 Operation

- Open the lens cover (9).
- Press and hold the **Power (6)** button for 2s to turn on the thermal imaging monocular.
- When an infrared image is displayed in the eyepiece, the thermal imaging monocular enters the operating status.
- Rotate the diopter adjustment knob (2) to adjust the resolution of the icon on the display. The diopter adjustment knob is used to adjust the eyepiece diopter for users with different degrees of myopia.
- **Setting the image mode:** briefly press the **Up (5)** button to set the image palette mode. There are five modes for selection: white hot (☀️), black hot (☾), red hot (🔥), pseudo color (🌈) and target highlight (🐦). The icon on the top status bar is updated in real-time.
- **Setting the display brightness:** press and hold the **M (4)** button to set the display brightness level from level 1 to level 5 in the menu (refer to

the section **Menu** for details).

- **Power off:** After using the device, press and hold the **Power (6)** button for 3 seconds to enter the power-off interface with a shutdown countdown. when the countdown icon turns to 0,

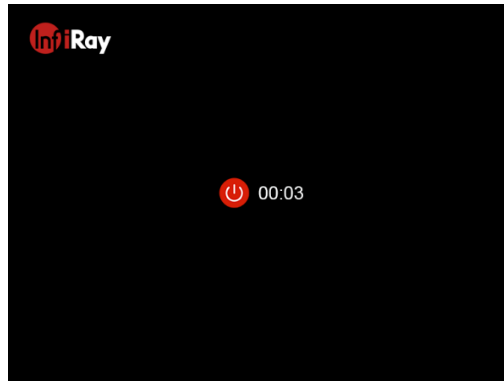

release the button. After the current status is saved, the display turns black and the device is powered off. **During the saving data, do not disconnect it from the power source, otherwise, the data cannot be saved.**

- **Standby:** On the home screen, press the **Power (6)** button briefly to standby the device. And press the **Power (6)** button again to wake up the device.

10 Calibration Mode

Calibration enables to equalize the detector temperature and eliminate the image defects (such as vertical bars, phantom images, etc.).

There are three calibration modes: Automatic (**A**), Manual (**M**) and Background (**B**).

Select the required calibration mode in the Menu (referring to the **Menu - Calibration**).

- **A mode (Automatic).** When select the automatic calibration mode, it will calibrate automatically according to the software algorithm. There is no need to close the lens cover (the internal shutter covers the sensor). In this mode, manual calibration is still supported by short pressing the **M (4) + Down (3)** buttons.
- **M mode (Manual).** When select the manual calibration mode, it only calibrates the sensor by manual. Short press the **M (4) + Down (3)** buttons to activate the shutter calibration without closing the lens cover (the internal shutter covers the sensor).
- **B mode (Background).** If you select the background calibration mode, press and hold the **M (4) + Down (3)** buttons to preform background calibration, a prompt appears on home



screen as “Cover lens during calibration”, and background calibration starts after 2s.

11 Digital Zoom

AFFO series support to quickly increase the basic magnification by 2 times or 4 times, as well as to return to the basic magnification.

- On the home screen, briefly press the M (4) button to cyclically enable the digital zoom of 1×, 2× or 4×. The zoom status is updated in the status bar on the top in real time.
- The AP09 and AP13 only support 2× zoom, the AL19 and AL25 support 2× and 4× zoom.



12 Photography and Video Recording

AFFO series is equipped with a function for video recording and photography of the observed image which is saved on the built-in 8GB memory storage.

The photo and video files are named with time, so it is suggested to reset

the date and time in the Menu before using the photo and video functions (refers to **Menu - Date Setting** and **Time Settings** in this manual) or to synchronize date and time in the **InfiRay Outdoor** application.

Photography

- On the home screen, short press the **Down (3)** button to take a photo.
- When taking a photo, the photo icon  flashes below the status bar in the upper left corner of the screen. The photo is taken successfully when the icon disappears
- If a red exclamation mark  appears after the photo icon, it indicates that the memory space is not insufficient, please clear the memory or move the footage to other storage media to free up the built-in memory space.
- Photos are stored in the built-in storage.



Video Recording

- On the home screen, press and hold the **Down (3)** button to start the video recording function.
- Then, the recording timer in the format of the HH: MM: SS (hour: minute: second) will appear on the upper right of the display.
- During recording, it is supported to take a photo with a short press of the **Down (3)** button. Of course, the other operations to the device are supported during recording.
- Press and hold the **Down (3)** button again to stop and save the video recording.
- All videos and photos will be saved in the build-in storage.



Memory Access

When the device is turned on and connected to a computer, it is recognized by the computer as a flash memory card, which is used to access the device's memory and make copies of pictures and videos.

- Connect the device to a computer through the Type C data cable.
- Power on the device for operation, and the USB function box pops up on the screen.
 - **Only for charging:** If you select this option, you can power the device through the computer and charge the built-in battery pack at the same time.
 - **Data reading:** Select this option, you can view the recorded videos and photos on the computer and charge the built-in battery pack at the same time.
 - **USB debugging:** Select this option, you can update the device program through the host computer and charge the built-in battery pack at the same time.
- Select the Data reading option by the **Up (5) / Down (3)** button, and confirm the selection with a short press of the **M (4)** button.
- Double click “my computer” on the computer desktop - select the USB flash disk and double click to access the memory space.

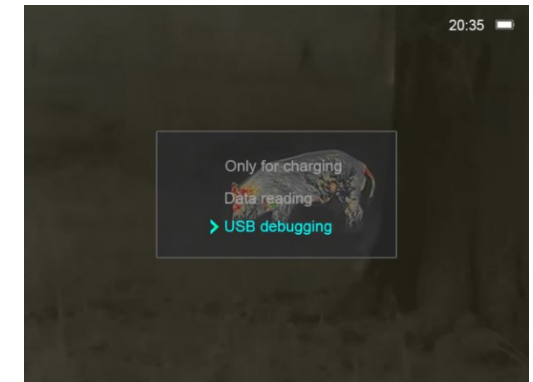

- There are four folders that are .MISC, LOCK-CIF, PHOTO-CIF and VIDEO-CIF.
- The captured videos and photos are respectively stored by time in the VIDEO-CIF and PHOTO-CIF folders.
- You can select required files or folders for copying or deleting operations.

Note

- Photo-taking and recording adopt the pre-distribution storage mode. That is, even if there is no photo or video file, the memory is full and this is normal.
- Do not delete files other than VIDEO-CIF folder and PHOTO-CIF folder. If you accidentally delete any of these files, you need to format the memory before using the device.
- The maximum duration of a video recording file is 5 minutes. When more than 5 minutes, the video will be recorded to a new file automatically.
- The captured videos and photos are respectively stored by time, so if a file is deleted from the list, its number is not taken by the other file.
- The interface icon information (status bar, icons and menu) is not displayed on the captured video or photo.

13 Video Output

The AFFO series supports analog video output and connect with an external display.

- Open the USB rubber cap **(10)** on the bottom of the device.
- Connect the Micro HDMI plug of the HDMI data cable to the Micro HDMI port **(13)** on the device.
- Connect another port of the HDMI data cable to the external display.
- Then the image can be played on the external display.
- Please note that the device cannot enter standby mode when HDMI is inserted.



14 Menu Function



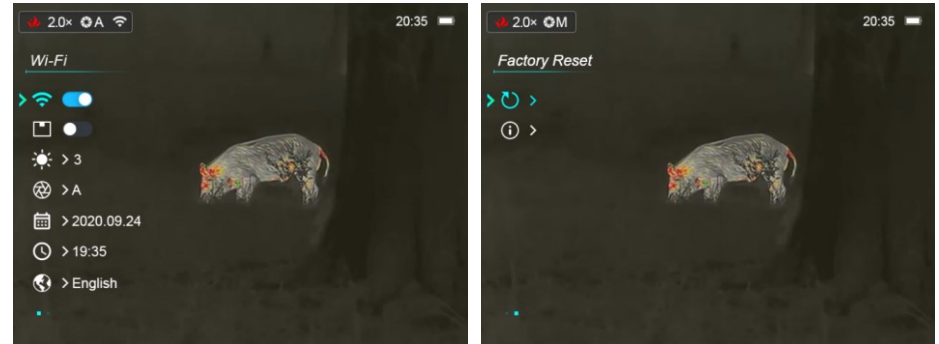

- On the home screen, press and hold the **M (4)** button to enter the menu interface.
- Briefly press the **Up (5) / Down (3)** button to switch among the menu options.
- Menu navigation is cyclical: as soon as the last menu option of the first tab is reached, the first menu option of the second tab starts.





- Adjust the current parameters or enter the submenus with a short press of the **M (4)** button.
- In all menu interfaces, short press the **Power (6)** button return to the home screen.
- Automatic exiting from the menu to the home screen will occur after 15 seconds of inactivity.





Menu Options and Descriptions

<p>Wi-Fi</p> 	<p>Turn Wi-Fi on/off</p> <ul style="list-style-type: none"> ● Press and hold down the M (4) button to enter the Menu interface. ● Select the Wi-Fi menu option with the Up (5) / Down (3) button. ● Briefly press the M (4) button to turn Wi-Fi on /off. ● When the Wi-Fi function is on, the icon will appear on the status bar in the upper left corner of the screen.
<p>PIP</p> 	<p>Turn PIP function on/off</p> <ul style="list-style-type: none"> ● Press and hold down the M (4) button to enter the Menu. ● Select the PIP menu option with the Up (5) / Down (3) button. ● Briefly press the M (4) button to turn PIP function on/off. ● When the PIP function is on, a small window and a blue box will appear on the screen. The image in the separate window is the 2x magnified image that is captured by the blue box in the main image.

<p>Display Brightness</p> 	<p>Set the display brightness level</p> <ul style="list-style-type: none"> ● Press and hold down the M (4) button to enter the Menu. ● Select the Display Brightness menu option with the Up (5) / Down (3) button. ● Briefly press the M (4) button to enter the submenu. ● There are five levels for selection. Select one level with the Up (5) / Down (3) button. ● Briefly press the M (4) button to confirm your selection and return to the menu interface. ● The default level is 3. 	
<p>Calibration</p> 	<p>Select calibration mode</p> <p>There are three calibration modes: Automatic(A), Manual (M) and Background (B).</p> <p>The selected calibration mode is displayed in the status bar.</p> <ul style="list-style-type: none"> ● Press and hold down the M (4) button to enter the Menu. ● Select the Calibration menu option with the Up (5) / Down (3) button. ● Briefly press of the M (4) button to enter the submenu. ● Press Up (5) / Down (3) button to select one mode from the following modes: <ul style="list-style-type: none"> - Automatic (A). The software determines the need for calibration in automatic mode. The calibration process starts automatically. - Manual (M). The user independently determines the need for calibration based on the quality of the observed image. - Background (B). Close the lens cover before starting the calibration. ● Briefly press M (4) button to confirm your selection and return to the menu interface. 	

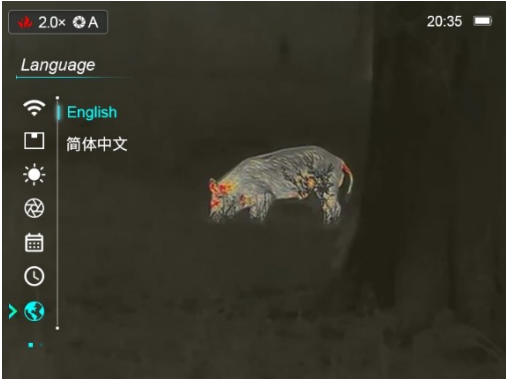
	<ul style="list-style-type: none"> ● The icon of the calibration mode will be displayed on the status bar.
<p>Date</p> 	<p>Set the date of the device</p> <ul style="list-style-type: none"> ● Press and hold down the M (4) button to enter the Menu. ● Select the Date Setting menu option with the Up (5) / Down (3) button. ● Briefly press the M (4) button to active the Date submenu. Two triangle icons will appear above and below the value. ● Date format is displayed as YY.MM.DD format (2020.01.01). ● Select the correct value for the year, month and day with a short press of the Up (5) / Down (3) button. ● Switch between digits with a short press of the M (4) button. ● Save selected date and exit the submenu with a long press of the M (4) button. ● Or, briefly press the Power (6) button to return to the home screen without saving. 
<p>Time</p> 	<p>Set the time of the device</p> <ul style="list-style-type: none"> ● Press and hold down the M (4) button to enter the Menu. ● Select the Time Setting menu option with the Up (5) / Down (3) button. ● Briefly press the M (4) button to active the Time submenu. Two triangle icons will appear above and below the value. ● Time format is displayed as HH:MM in 24-hours format (14:48). ● Select the correct value for the hour and minute with a short press of the Up (5) / Down (3) button. ● Switch between digits with a short press of the M (4) button. 

	<ul style="list-style-type: none"> ● Save the selected time and exit the submenu with a long press of the M (4) button. ● Or, briefly press the Power (6) button to return to the home screen without saving.
<p style="text-align: center;">Language</p> 	<p>Set the GUI Language</p> <ul style="list-style-type: none"> ● Press and hold down the M (4) button to enter the Menu. ● Select the Language menu option with the Up (5) / Down (3) button. ● Briefly press the M (4) button to enter the submenu of the language. ● Select the desired language with a short press of the Up (5) / Down (3) button. AFFO series support English and Chinese two languages. ● Confirm your selection with a short press of the M (4) button and return to the menu interface automatically. 
<p style="text-align: center;">Factory Reset</p> 	<p>Reset to Factory Settings</p> <ul style="list-style-type: none"> ● Press and hold down the M (4) button to enter the Menu on the home screen. ● Select the Factory Reset menu option with the Up (5) / Down (3) button. ● Enter the Factory Reset submenu with a short press of the M (4) button. ● Briefly press the Up (5) / Down (3) button to select Yes or No. ● Confirm your selection with a short press of the M (4) button. ● If Yes is selected, the device will complete the factory reset. ● If No is selected, the action will be cancelled and will return to the menu interface. 
<p style="text-align: center;">Info</p>	<p>Show device information</p> <ul style="list-style-type: none"> ● Press and hold down the M (4) button to enter the Menu on the home screen.



- Select the **Info** menu option with the **Up (5) / Down (3)** button.
- The relevant information of the device will be shown by a short press of the **M (4)** button.
- This item allows the user to view the following information: the product model, SN number, PN number, hardware version, software version and the core version.
- Press the **Power (6)** button briefly to return to the home screen.

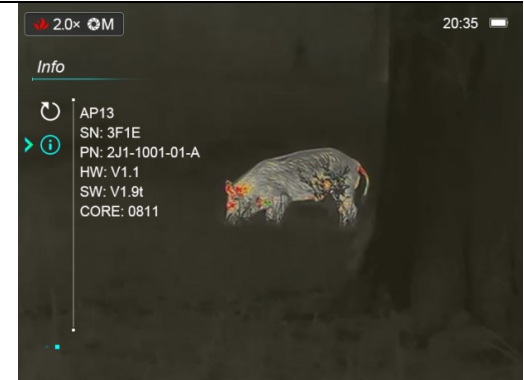

15 Stadiametric Rangefinder

AFFO series support the stadiametric rangefinder function, which allows user to estimate the approximate distance to an object with a known size.

- On the home screen, press and hold the **Up (5) + M (4)** buttons simultaneously to enter the stadiametric rangefinder mode.
- When this function is on, two horizontal lines for measurement will appear on the display, meanwhile icons of three predefined objects and measured values will be displayed on the right side.
- Three pre-defined target values are provided as follows:
 - Deer: 1.7m high
 - Wild boar: 0.9m high

- Hare: 0.2m high

- Locate the object in the middle of the measurement lines.
- Widen or lessen the measurement line to ensure that the measured object is within the line with short or long press of the **Up (5) / Down (3)** button.
- When you adjust the width of the measurement line, the rangefinder data on the right changes accordingly.
- Press and hold the **Up (5) + M (4)** buttons again to exit the stadiametric rangefinder function.

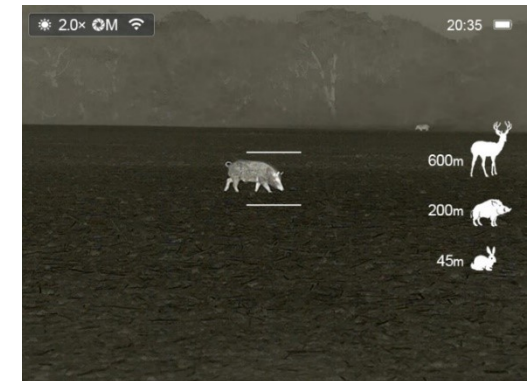

16 Hotspot Tracking

The AFFO series provides hotspot tracking function, which allows you to track the hottest object in the image.

- On the home screen, press and hold the **Up (5) + Down (3)** buttons to turn on the hotspot tracking function.
- A blue box will appear in the image and track the hottest object automatically.



- Press and hold the **Up (5) + Down (3)** buttons again to exit the hotspot tracking function.

17 PIP Function

The PIP (Picture in Picture) function allows you to see both a magnified image in a particular window and the main image. This window shows part of the image which is enlarged to 2x in a certain area of the main image.

- On the home screen, press and hold the **M (4) button** to enter the menu

interface.

- Select the PIP option with the **Up (5) / Down (3)** button.
- Turn the PIP function on with a short press of the **M (4)** button.
- When the PIP function is on, a small window and a blue box will appear on the screen. The image in the separate window is the 2x magnified image that is captured by the blue box in the main image, when the laser indicator is turned on, zoom in with the laser cursor as the center.
- When the main image is enlarged with a short press of the **M (4) button**, the PIP image will synchronously be enlarged two times.
- For example, when the magnification of the main image is 1x, 2x, 4x, the corresponding magnification of the PIP image is 2x, 4x, 8x.



18 Wi-Fi

The AFFO series is built-in Wi-Fi module for wireless communication with mobile devices (smartphone or tablet) via Wi-Fi.

- Press and hold down the **M (4)** button to enter the Menu.
- Select the Wi-Fi menu option with the **Up (5) / Down (3)** button.
- Turn Wi-Fi function on /off with a short press of **M (4)** button.
- After the Wi-Fi of the device is enabled, search for the Wi-Fi signal with the name such as AP13_XXXXXX on the mobile device, among which XXXXXX is a 6-bit serial number composed of digits and letters.
- Select this Wi-Fi, enter the password on the mobile to set up the connection. The initial password is 12345678.
- After Wi-Fi is successfully connected, you can control the device via the mobile app.
- Launch **InfiRay Outdoor** application on your mobile device (refer to the section **Update and InfiRay Outdoor**).

Setting Wi-Fi name and password

The Wi-Fi name and password of AFFO series can be reset in the **InfiRay Outdoor** application.

- After connected to the mobile device, find and click the "Setting" icon  in the **InfiRay Outdoor** image screen to



enter the setting interface.

- In the text box, enter and submit the new Wi-Fi name (SSID) and password.
- After submitting the change, reboot the device take the new name and password effect.

Note

- When factory Settings are restored, the Wi-Fi name and password are also restored to factory default settings.

19 Updates and InfiRay Outdoor

The AFFO series thermal imager supports **InfiRay Outdoor** technology, which allows you to transmit the image from the thermal imager to the smartphone or tablet via Wi-Fi in real time mode.

You can find detailed instructions about **InfiRay Outdoor** at the official website www.infirayoutdoor.com.

The design of the AFFO series provides the software update option. Updating is possible via the **InfiRay Outdoor** application. Also, it is feasible to download and update software from the official website:

www.infirayoutdoor.com.

About InfiRay Outdoor

- You can get **InfiRay Outdoor** application in the official website, or search **InfiRay Outdoor** in App store or scan the following QR code to download.

- When installation is completed, open it.
- If your device has been connected to a mobile device, please switch on the mobile data in mobile device. After the device accesses the Internet, an update prompt will be displayed automatically. Click **Now** to download the latest version immediately or click **Later** to update later.
- **InfiRay Outdoor** saves the last connected device automatically. Therefore, once you link to InfiRay Outdoor before, it will automatically detect an update in the background even when the device is not connected to a phone or laptop. If an update is available and the mobile device accesses the internet, you can download the update first. Then, when the device is connected to the mobile device, the version will be updated automatically.

- After the update is installed, the device will root.

20 Technical Inspection

It is recommended to carry out a technical inspection each time before using the monocular. Check the following:

- The appearance (there should be no cracks on the body).
- The condition of the object lens and eyepiece (there should be no cracks, greasy spots, dirt or other deposits).
- The battery status (it should be charged).
- The controls/buttons should be in working order.

21 Legal and Regulatory Information

Wireless transmitter module frequency range:

WLAN: 2.412-2.472GHz (For EU)

Wireless transmitter module power < 20dBm (only for EU)

 We, IRay Technology Co., Ltd. hereby declares that the radio equipment AFFO series is in compliance with the Directives 2014/53/EU, 2011/65/EU and RER 2017 (SI 2017/1206). The full text of the EU&UK declaration of conformity is available at: www.infirayoutdoor.com.

FCC Statement

FCC ID: 2AYGT-AFFO

Labeling requirements

This device complies with part 15 of the FCC Rules. Operation is subject to the following two conditions: (1) This device may not cause harmful interference, and (2) this device must accept any interference received, including interference that may cause undesired operation.

Information to the user

Any Changes or modifications not expressly approved by the party responsible for compliance could void the user's authority to operate the equipment.

Note: The manufacturer is not responsible for any radio or TV interference caused by unauthorized modifications to this equipment. Such

modifications could void the user's authority to operate the equipment.

Note: This equipment has been tested and found to comply with the limits for a Class B digital device, pursuant to part 15 of the FCC Rules. These limits are designed to provide reasonable protection against harmful interference in a residential installation. This equipment generates uses and can radiate radio frequency energy and, if not installed and used in accordance with the instructions, may cause harmful interference to radio communications. However, there is no guarantee that interference will not occur in a particular installation. If this equipment does cause harmful interference to radio or television reception, which can be determined by turning the equipment off and on, the user is encouraged to try to correct the interference by one or more of the following measures:

- Reorient or relocate the receiving antenna.
- Increase the separation between the equipment and receiver.
- Connect the equipment into an outlet on a circuit different from that to which the receiver is connected.
- Consult the dealer or an experienced radio/TV technician for help.

This device meets the government's requirements for exposure to radio waves. The guidelines are based on standards that were developed by

independent scientific organizations through periodic and thorough evaluation of scientific studies. The standards include a substantial safety margin designed to assure the safety of all persons regardless of age or health.

The highest SAR value reported under this standard during product certification for use at the ear is 0.5W/kg and when properly worn on the body is 0.49W/kg. This device was tested for typical body-worn operations with the back of the handset kept 0.5cm from the body.

Body-worn Operation

This device was tested for typical body-support operations. To comply with RF exposure requirements, a minimum separation distance of 0.5cm must be maintained between the user's body and the handset, including the antenna. Third-party belt-clips, holsters, and similar accessories used by this device should not contain any metallic components. Body accessories that do not meet these requirements may not comply with RF exposure requirements and should be avoided. Use only the supplied or an approved antenna.

Power adapter manufacturer

Shenzhen Simsukian Electronics Technology Co., Ltd.

Add: Simsukian Industrial Park, Jiayi Industrial Zone, Guihua Village,
Guanlan Street, Longhua District

Shenzhen P.R. China

Model No.: SK22G-0500200Z

Input: 100-240V~50/60Hz, MAX/0.35A

Output: 5.0V $\overline{\text{---}}$ 2.0A 10.0W