



IRay Technology Co., Ltd.

Add: 11th Guiyang Street, YEDA, Yantai, P.R. China

Tel: 0086-400-998-3088

Email: infirayoutdoor@infiray.com

Web: www.infirayoutdoor.com

www.infirayoutdoor.com

Infiray Outdoor • Geni Series • Operating Manual

Operating Manual

V1.0

Geni Series | Thermal Imaging Scope

GL35/GH35/GL50/GH50

IMPORTANT SAFETY INFORMATION

Environmental influences

Note: Never point the lens of the device directly at intense heat sources such as the sun or laser equipment. The objective lens and eyepiece can function as a burning glass and damage the interior components.

Risk of swallowing

Caution: Do not place this device in the hands of small children. Incorrect handling can cause small parts to come loose which may be swallowed.

Safety instructions for use

- Do not expose the device to fire or high temperatures.
- The battery capacity decreases when operated in a cold ambient temperature. This is not a fault and occurs for technical reasons.
- Always store the device in its carrying bag in a dry, well-ventilated space.
For prolonged storage, remove the batteries.
- Do not expose your device to extreme temperatures lower than - 20°C and higher than + 50°C.
- The product shall only be connected to a USB Type C interface.

- If the device has been damaged or the battery is defective, send the device to our after-sales service for repair.

User information on the disposal of electrical and electronic devices (private households)

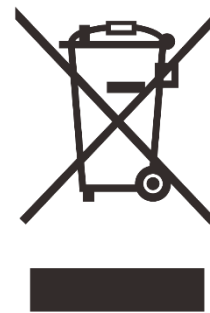

The WEEE symbol on products and/or accompanying documents indicates that used electrical and electronic products must not be mixed with ordinary household waste. For proper treatment, recovery and recycling, take these products to the appropriate collection points where they will be accepted without charge. In some countries, it may also be possible to return these products to your local retailer when you purchase a corresponding new product. The proper disposal of this product serves to protect the environment and prevents possible harmful effects on human beings and their surroundings, which may arise as a result of incorrect handling of waste.

More detailed information on your nearest collection point is available from your local authority. In accordance with state legislation, penalties may be imposed for the improper disposal of this type of waste.

For business customers within the European Union

Please contact your dealer or supplier regarding the disposal of electrical and electronic devices. He will provide you with further information.

Information on disposal in other countries outside of the European Union

This symbol is only applicable in the European Union. Please contact your local authority or dealer if you wish to dispose of this product and ask for a disposal option.

Intended use

The device is intended for displaying heat signatures during nature observation, remote hunting observations and for civil use. This device is not a toy for children.

Use the device only as described in this instruction manual. The manufacturer and the dealer accept no liability for damages which arise due to non-intended or incorrect use.

Function test

- Before use, please ensure that your device has no visible damage.
- Test to see if the device displays a clear, undisturbed image.
- Check that the settings for the thermal imaging camera are correct. See the notes in the section Observation mode.

Installing/removing the battery

The Geni series thermal imaging scope is equipped with two power supply systems – one built-in battery pack and one replaceable 26650 battery for use. The built-in battery pack cannot be removed.

Observation with and without glasses

Thanks to the flexible eyeshade, the Geni series can be used with or without glasses. It offers a full field of view in both cases.

1 Technical Specifications

Model	GL35	GH35	GL50	GH50
Microbolometer				
Type	Uncooled			
Resolution, pixels	384×288	640×512	384×288	640×512
Pixel Size, um	12			
NETD, mk	≤35			
Frame Rate, Hz	50			
Optical Characteristics				
Objective Lens	F35mm /1.0		F50mm /1.1	
Field of View, degrees	7.5×5.7	12.6×9.4	5.3×4.0	8.8×6.6
Magnification, ×	3~12	2~8	4~16	3~12
E-zoom, ×	1 / 2 / 3 / 4			
Eye relief, mm	40	48	40	48
Diopter Adjustment, D	-4~+4			
Detection Range, m (Target size: 1.7m×0.5m, P(n)=99%)	1818		2597	
Display				
Type	AMOLED			
Resolution, pixels	1024×768			
Size, inch	0.39			
Power Supply				

Battery Type / Capacity	4400mAh Internal battery + 3300mAh Replaceable battery			
Max. Operating Time (at t=22°C), h [★]	10h			
External Power Supply	5V (Type C USB)			
Operational Characteristics				
Max. Recoil Power on Rifled Weapon, m/s ²	1000g (g=9.8 m/s ²)			
Degree of protection, IP code	IP67			
Amount of built-in memory, Gb	32			
Operating Temperature Range, °C	-20~+50			
Weight, g	<730g	<740g	<780g	<780g
Dimension, mm	225x63x90	235x63x90	238x70x90	248x70x90

- ★ The actual operating time depends on the intensity of using Wi-Fi, video recorder.
- Improvements may be made to the design and software of this product to enhance its features;
- If there is any change to the technical specifications of the product, it will be made without prior notice to the customer.

2 Package Contents

- Thermal Imaging Riflescopes
- IRM-030-205-Q1 picatinny mount
- IBP-2 battery pack
- IBC-2 battery charger for battery pack
- Power adapter
- Data cable
- IPB-3 portable bag
- Lens cloth
- A L-shaped wrench

3 Description

The thermal imaging riflescope Geni series are designed for the use on hunting rifles both in the nighttime and in the daylight in inclement weather conditions (rain, snow, fog or smog) to see through obstacles hindering detection of targets (tree branches, tallgrass and shrub etc.). Unlike the night vision devices, the Geni series do not require an external source of

light and are not affected by strong lights. Geni series can be widely used in the night hunting, observation and terrain navigation, search and rescue operations etc.

4 Features

- 12 μ m high resolution thermal detector
- High image quality
- Maximum detection range 1818 / 2597m
- 4400mAh Internal battery + 3300mAh replaceable battery
- HD AMOLED display:1024*768
- High frame frequency: 50Hz
- Three save sort for rifle types, variable reticle types and color
- Digital Zoom: $\times 1/\times 2/\times 3/\times 4$
- Build-in 32GB storage, supports photographing and video recording
- Build-in Wi-Fi module, support **InfiRay Outdoor App**
- Build-in digital compass and motion sensor
- Ultraclear mode
- User friendly interface

5 Components and Controls

1. Eyeshade
2. Eyepiece adjustment ring
3. Type C port
4. Down button / Photography button
5. Menu / M button
6. Up button / Zoom button
7. Power button
8. Side picatinny
9. Lens cover
10. IBP-2 battery pack
11. Lens focus ring/knob
12. Objective lens





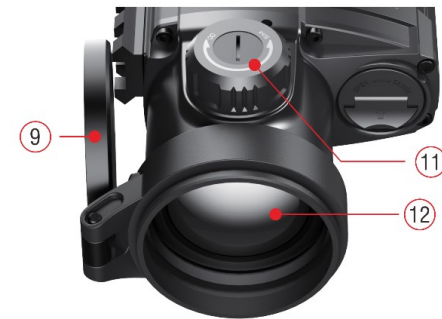

GL35/GH35



GL50/GH50

6 Description of Controls

Button	Current Status	Short Press	Long Press
Power Button 	Device is off	—	Power on the device
	Device is on	Standby the device	Power off
	Standby mode	Wake up the device	—
	Main menu	Exit to home screen	Power off
	Defective pixel calibration	Add / Delete defective pixel	Power off
Up / E-zoom Button 	Home screen	Digital Zoom	Turn range notification on/off
	Main menu / Quick menu	Navigation upwards	—
Menu Button 	Home screen	Enter quick menu	Enter main menu
	Quick menu	Switch and confirm parameters	Exit to the upper interface
	Main menu	Enter the submenu / Confirm selection	
	Defective pixel calibration	Confirm selection / Save position	
Down/Photography Button 	Home screen	Take a Photograph	Start video recording
	Main menu / Quick menu	Navigation downwards	—
	Video recording	Take a Photograph	Stop and save video
Up + Down Button	Home screen	Calibrate the detector	Background correction
	Zeroing interface	—	Freeze the image
Menu + UP Button	Home screen	Turn the PIP function on/off	Turn stadiametric rangefinder on
Up + Menu + Down Button	Home screen	—	Turn reticle function on/off

7 Battery Pack

Geni series are supplied with a rechargeable Li-ion Battery Pack IBP-2 which allows operation for up to 5 hours. Please Remember to charge the Battery Pack before first use.

Battery Pack Installation

- Turn up the puller (14) on the battery pack (10), and align the positioning block (A) of the battery pack (10) with the groove (B) of the battery compartment on the Geni, and push the battery pack (10) into the battery slot (13).
- When the battery pack is completely inserted into the battery slot, turn the puller (14) clockwise to lock the battery pack.

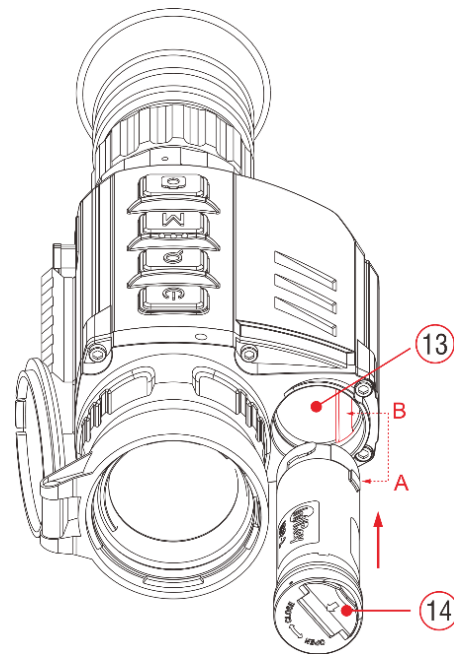

- Close the puller (14), and the battery pack is completely installed.
- Geni can only be powered by this battery pack. If other battery packs are used, it may cause irreparable loss, damage to the device, and can even possibly cause fire.

Charging with Type-C Port

- Install the battery pack into the battery compartment of the product. For details, see **Battery Pack Installation**.
- Connect the Type C end (18) of the data cable to the Type C port (3) of the product.

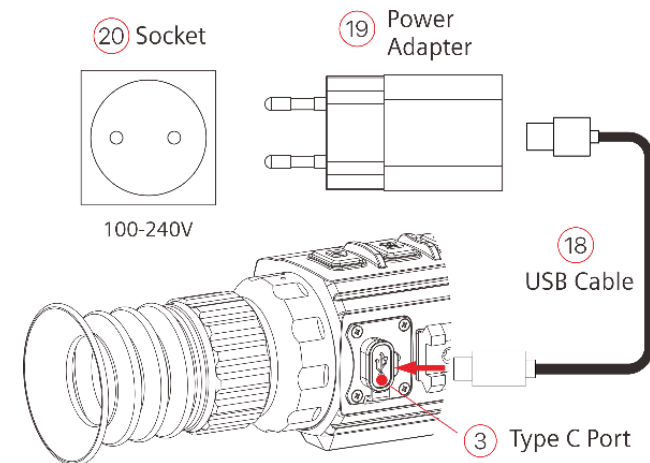

- Connect the other end of the data cable to the power adapter (19) that comes with the product, or connect to another USB power socket with

a rated output voltage not exceeding 5V.

- Plug the adapter into a 100-240V power socket (20) for charging.

Charging with Battery Charger

- Align the positioning block (A) of the battery pack (10) with the groove (B) of the battery charger (15), and insert the battery pack (10) into the battery charger (15).
- Connect the plug of the USB Type-C cable (18) to the USB connector of the power adapter (19). Plug the power adapter (19) into a socket 100-240V (20) (110V for US).
- Connect the other end of the USB cable (18) to the Type-C port (16) of the battery charger (15).
- After finishing the above steps, the LED indicator (17) on the battery charger (15) will display the battery charge state.
 - ● Battery level is from 1% to 25%
 - ● ● Battery level is from 25% to 50%
 - ● ● ● Battery level is from 50% to 75%
 - ● ● ● ● Battery level is from 75% to 99%
 - ● ● ● ● The battery is fully charged.

- After the battery is fully charged, remove the battery pack from the battery charger.

Note: Two batteries can be charged at the same time: the second slot is designed for it.

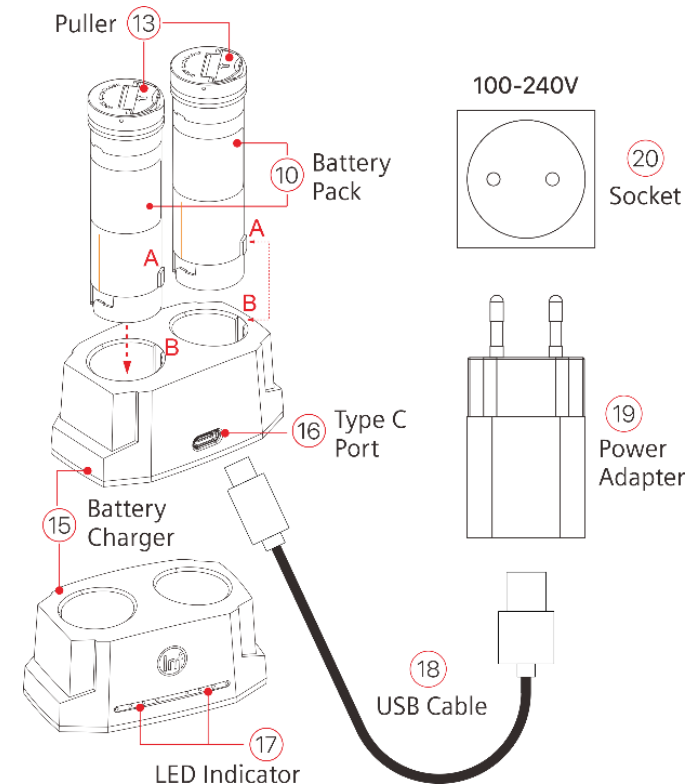

Safety Precautions

- Only use the battery charger **(15)** supplied with the Battery Pack. The use of any other charger may irreparably damage the Battery Pack or the charger and may cause fire.
- Partial charging the battery is necessary if the battery is planned to be idled for long time. Avoid fully charged or discharged.
- Don't charge the battery instantly while bring the battery from cold environment to warm environment. Leave 30 to 40 mins before charging.
- Don't leave battery unattended when charging;
- Never use a damaged or modified charger;
- Charge the Battery Pack at a temperature from 0°C to +45°C, otherwise the battery life will be reduced significantly.
- Don't leave the Battery Pack with a charger connected to the mains longer than over 24 hours after full charge.
- Do not expose the battery pack to high temperature or to a naked flame.
- Do not submerge the battery pack in water.
- Don't connect external device with a current consumption that exceed permitted levels.
- The Battery Pack is short circuit protected. However, any situation that may cause short-circuiting should be avoided;
- Don't dismantle or deform the Battery Pack.
- Don't hit or drop the battery
- The battery capacity may decrease when using the battery in negative temperature, that is normal, not a defect.
- Avoid using the battery at the temperature above the temperature shown in the table, this may decrease the battery's life.
- Keep the battery out of the reach of children.

8

External Power Supply

Geni series support external power supply, such as the mobile power bank (5V).

- Connect the external power supply to the USB port **(10)** on Geni.
- The riflescope will switch to operation from external power supply, and the battery will begin slowly charging. The internal battery charges first, then the external battery

- The display will show the battery icon  .

9 Operation

Installation of Rifle Mount

- Before using the Geni series, you need to install the Rifle Mount **(21)** on the bottom of your riflescope.
- The mounting holes **(24)** in the base of the riflescope enable the Mount **(21)** to be installed in one of the multiple positions.
- The choice of the mounting position helps the user to ensure the correct eye relief distance depend on the rifle type.
- Fix the Rifle Mount **(21)** to the base of the riflescope with a L-shaped wrench **(23)** and M5 screws **(22)** supplied in the package.
- Install the riflescope on your hunting weapon and make sure that the chosen position is suitable for you.
- Remove the riflescope from your weapon.
- Unscrew the screws one by one, apply some thread sealant onto the thread of screws and tighten them fully (do not overtighten). Let the

sealant dry for a while.

- While the sealant is dry, the riflescope is ready to be installed on your weapon and to be zeroed.
- After first installation of the riflescope on your weapon. Please follow instructions in the section 9 **“Zeroing”**.

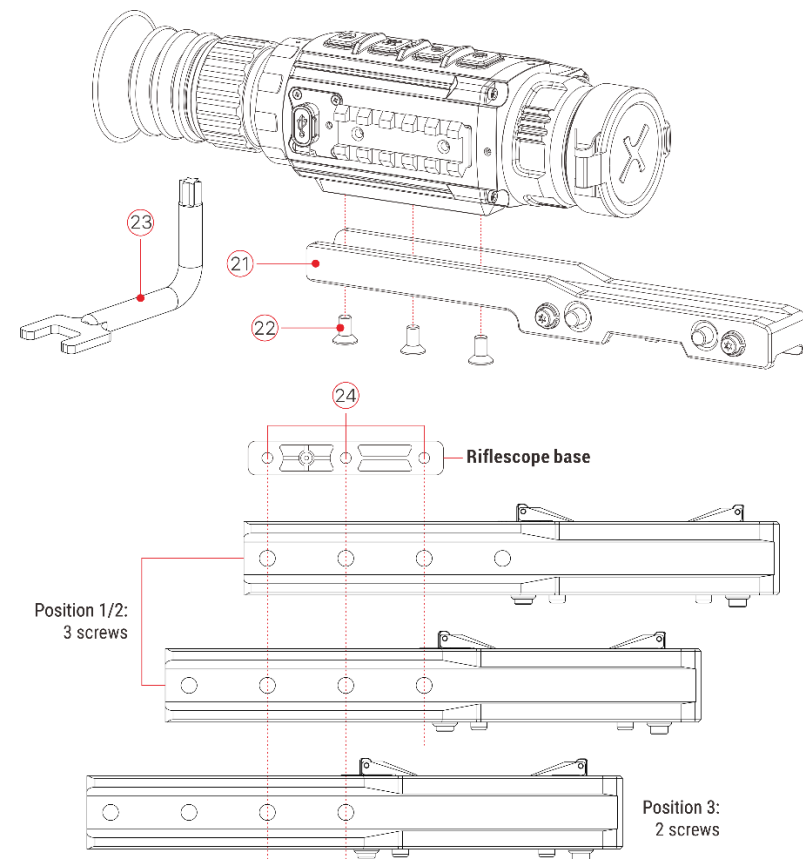

Power On and Image Settings



- Open the lens cover (9).
- Press and hold down the **Power (7)** button to turn on the scope.
- Rotate eyepiece diopter adjustment ring (2) until images in eyepiece are clear. After this, there is no need to rotate the eyepiece adjustment ring (2) for distance or any other conditions.
- Rotate the lens focus ring (11) to focus on the object being observed.
- To set up display brightness, image contrast, image modes and digital zoom, please refer to the **Quick Menu Function** section.
- After use, hold down the **Power (7)** button for about 3 seconds, there will be prompts of countdown of switch off. Release the button until a prompt of saving data appears on the screen after counting down from 3 to 0, and the device will switch off after saving data. **Please don't cut off power supply when saving data, otherwise the data may not be saved.**

10 Zeroing

Geni series feature to use the “Freeze” zeroing method. Zeroing should be done at the operation temperatures by following the order of these steps:

- Mount Geni on your weapon according to the instructions of section 8 **Installation of Rifle Mount.**
- When using Geni for the first time, press the **Up (6) + M (5) + Down (4)** three buttons at the same time for more than 10 seconds to active the hidden functions about reticle and zeroing functions.
- Set a target at a certain distance.
- Adjust the riflescope according to the instructions of section 8 **Power on and image settings.**
- Select the zeroing profile (refer to “Reticle - Zeroing Profile” in Main Menu).
- Press and hold down the **M (5)** button to enter the Main Menu.
- Briefly press the **Up (6) / Down (4)** button to select the **Zeroing** item. Then press **M (5)** button to enter the submenu.
- Base on the preset target distance to select zeroing distance in the zeroing submenu or add a new distance (refer to Main Menu option

Zeroing - submenu **Zeroing Distance - Reset Zeroing Distance**).

- After setting the zeroing distance, select the Zeroing option  and briefly press the **M (5)** button to enter Zeroing interface (see the Main Menu Option **Zeroing** - submenu **Zeroing Distance** - submenu **Zeroing**). The X and Y coordinates of the reticle are displayed in the upper left corner of the screen.
- Aim and shoot the target.
- Observe the location of impact. Suppose that the red cross hairs in the right picture represents the impact point, but the cross is only as a sign and does not appear on the actual interface.
- If the impact point does not match the aiming point (the center of the reticle), keep the reticle center the aiming point, then press and hold down the **UP (6) + Down (4)** buttons at the same time until a symbol of freeze  appears on the left of the screen, and the image is frozen.
- Move the reticle with the **Up (6) / Down (4)** button until the reticle matches the point of impact.
- Briefly press the **M (5)** button to switch the movement direction between X (the default direction) and Y. The location of cursor  represents the

current selected option, and the icon turns into blue.

- Press the **Up (6)** button to move the reticle right or up and the **Down (4)** button to move the reticle left or down.
- When moving the reticle, a white dot appears on the screen, representing the original position of the reticle.
- When the reticle moves to the impact point, press and hold the **M (5)** button to save the new position of the reticle and exit to the home screen.
- Take another shot - the point of impact should now match the aiming point.



11 Calibration

Calibration enables to equalize the detector temperature and eliminate the

image defects (such as vertical bars, phantom images, etc.).

There are three calibration modes: Automatic (**A**), Manual (**M**) and Background (**B**).

Select the required calibration mode in the Main Menu.

- **A mode (Automatic)**. Device will calibrate automatically according to the software algorithm. There is no need to close the lens cover (the internal shutter covers the sensor). Before automatic calibration, there will be a 5 second countdown prompt behind the shutter icon on the status bar, that can be cancelled this calibration during countdown with a short press of the **Power (7)** button. In this mode, the riflescope may be calibrated by user with the **Up (6) + Down (4)** buttons.
- **M mode (Manual)**. Press the **Up (6) + Down (4)** buttons briefly to activate the shutter calibration without closing the lens cover (the internal shutter covers the sensor).
- **B mode (Background)**. Close the lens cover and press **Up (6) + Down (4)** buttons briefly. A prompt appears on home screen as “cover lens during calibration”, background calibration starts after 2s.

12 Digital Zoom

Geni series support to quickly increase the basic magnification by 2 times, 3 times or 4 times, as well as to return to the basic magnification.

- In the home screen, briefly press the **Up (6)** button to operate the incremental digital zoom. in loop to switch magnification times and the status reveal on the top status bar.

13 Photography and Video Recording

Geni series is equipped with a function for video recording and photography of the observed image which is saved on the built-in 32GB memory storage. The photo and video files are named with time, so it is suggested to reset the date and time in the Main Menu before using the photo and video functions (refers to **Main Menu - Settings - Date/Time Setting** in this manual) or to synchronize date and time in the InfiRay Outdoor application.

Photography

- Press the **Photography (4)** button in the home screen to take a photo.

The image freezes for 0.5 sec with a camera icon  appears on the upper left corner of screen.

- Photos are stored in the built-in storage.



Video Recording

- In the home screen, press and hold down the **Photography (4)** button to start video recording.
- When the video recording starts, the icon  and the video recording timer displayed in the HH:MM:SS (hour: minute: second) format will appear on the upper right of the screen.
- When recording, short press the **Photography (4)** button to take a photo.
- Press and hold down **Photography (4)** button to stop and save the video recording.
- All videos and photos will be saved in the build-in storage.



Tips:

- You can enter and navigate the menu during video recording.
- Recorded photos and videos are saved in built-in memory card of the device in the format IMG_HHMMSS_XXX.jpg (for photos) and VID_HHMMSS_XXX.mp4 (for videos). HHMMSS - Hour/Minute/Second; XXX - three-digit counter (for videos and photos).
- The counter used for the names of multimedia files can't be reset.
- If a file is deleted from the list, its number is not taken by the other file.

Caution:

- The maximum duration of a recorded video file is 5 minutes. After this time expires, the video is recorded to a new file automatically.
- The number of the recorded files is limited by the capacity of the internal memory.
- Check the available space of the built-in storage card regularly and move the footage to other storage media to free up the memory card space.
- Graphic data (status bar, icons and menu) in the recorded video and photo files are not displayed.

Memory Access

When the device is turned on and connected to a computer, it is recognized by the computer as a flash memory card, which is used to access the device's memory and make copies of pictures and videos.

- Turn on the riflescope and connect it with the computer via Type-C cable.
- Double click “my computer” on the desktop - double click to open the device named “InfiRay” - double click and open the device named ‘Internal Storage’ to access built-in memory.
- There are different folders named by time in the storage.
- Recorded photos and videos in that day are saved in the folders
- Select desired files or folders to copy or delete.





14 Status Bar



The status bar is at the top of the screen and shows information on the

actual operating status of the riflescope, from left to right are:

1. Current image mode (☀️: White Hot; 🌑: Black Hot; 🔥: Red Hot; 🐦: Target Highlight; 🌈: Pseudo color)
2. Actual zeroing type and distance (such as A100m)
3. Ultraclear mode (👁️: Ultraclear off; 👁️: Ultraclear on)
4. Current magnification (such as 3.0×)
5. Calibration mode (a countdown timer ⌚00:05 will appear instead of the calibration mode with 5 seconds remaining until automatic calibration). The timer will appear only after the microbolometer temperature has stabilized (after 10 minutes of continuous operation of the riflescope). Immediately after turning on the riflescope the shutter calibration activates automatically without displaying the timer.
6. Compass (when it is on)
7. Standby status and time
8. Microphone status (🔇: Mic is off; 🗣️: Mic is on)
9. Wi-Fi Status (📶: Wi-Fi off; 📶: Wi-Fi on)
10. Clock (set clock in the App “InfiRay Outdoor” or the Main Menu)
11. IBP-2 Battery Pack status
12. Replaceable battery status

Icon	Color/Status	Battery Status
	Green	more than 40%
	Yellow	20% - 40%
	Red	Less than 20%, need to charge instantly
	Lightning icon inside	External power supply meanwhile charging the Battery Pack
	USB icon	External power supply without Battery Pack in the riflescope

15 Quick Menu Function

The basic settings (including image mode, display brightness, image sharpness and zeroing distance) can be changed in the Quick Menu.

- In the home screen, short press the **M (5)** button to enter the Quick Menu.
- Switch the function items as described below with a short press of **Up (6) / Down (4)** button. The selected items will be highlighted in background:
 - **Image Mode:** short press the **M (5)** button to switch image modes

among White Hot, Black Hot, Red Hot, Pseudo Color and Target Highlighting mode.

- **Display Brightness:** short press the **M (5)** button to change brightness level from 1 to 5.
 - **Image Sharpness:** short press the **M (5)** button to switch the image sharpness from 1 to 5.
 - **Zeroing Distance:** short press the **M (5)** button to change default zeroing distance under the current zeroing profile (if you select the profile A, you can only switch the distance saved in the profile A).
- Press and hold down the **M (5)** button to save modifications and exit the menu or wait 5 seconds to exit automatically.

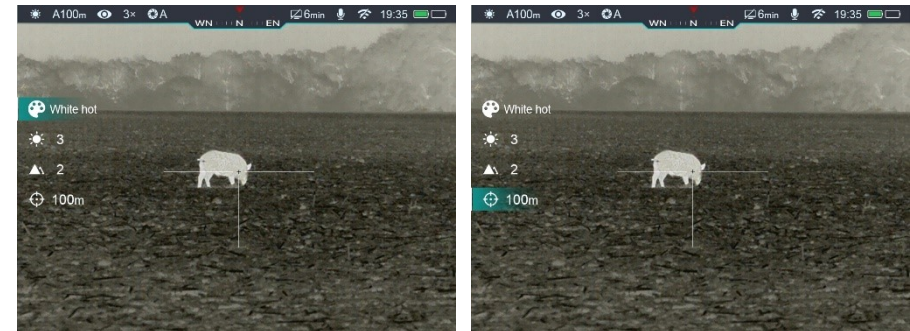

16 Main Menu

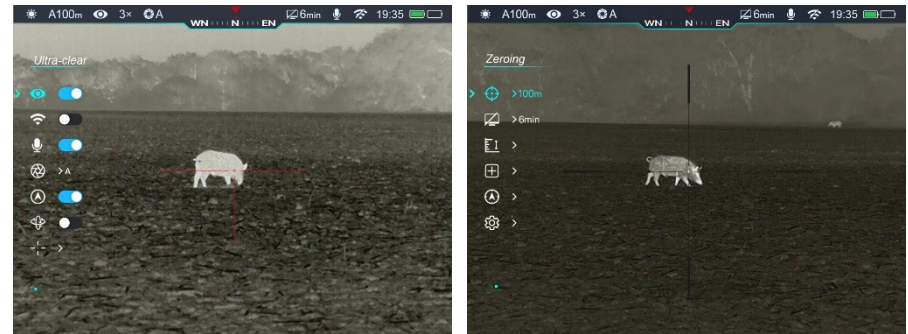

- Enter the main menu with a long press of the **M (5)** button in home screen.
- Briefly press the **Up (6) / Down (4)** button to toggle between the main menu options.
- Main menu navigation is cyclical: as soon as the last menu option of the first tab is reached, the first menu option of the second tab starts.
- Adjust the current parameters or enter the submenus with a short press of the **M (5)** button.
- In all menu interfaces, long press the **M (5)** button to save the modification and exit to the home screen. And short press the **Power (7)** button to return to the previous menu without saving.

- Automatic exiting from the main menu to the home screen will occur after 15 seconds of inactivity.
- Upon exit from the main menu the cursor location is stored only for a single working session (i.e. until the riflescope is turned off). Upon restarting the riflescope and entering the menu the cursor will be on the first menu item.













Main Menu Options and Descriptions





<p>Ultraclear</p> 	<p>Turn Ultraclear mode on/off</p> <ul style="list-style-type: none"> ● Press and hold down the M (5) button to enter the Main Menu. ● Select the Ultraclear menu option with the Up (6) / Down (4) button. ● Turn Ultraclear mode on /off with a short press of M (5) button, along with the sound of shutter calibration.
--	---

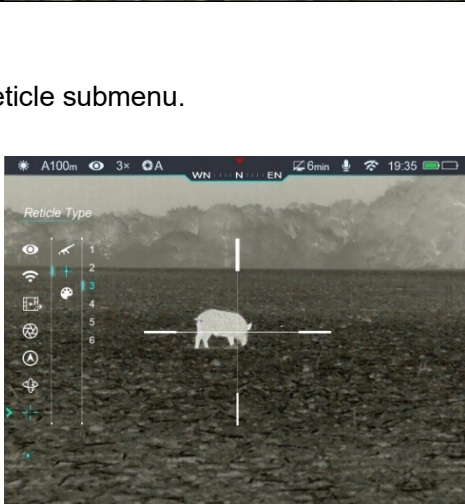

<p>Wi-Fi</p> 	<p>Turn Wi-Fi on/off</p> <ul style="list-style-type: none"> ● Press and hold down the M (5) button to enter the Main Menu. ● Select the Wi-Fi menu option with the Up (6) / Down (4) button. ● Briefly press of the M (5) button to turn Wi-Fi on /off
<p>Microphone</p> 	<p>Turn Microphone on/off</p> <ul style="list-style-type: none"> ● Press and hold down the M (5) button to enter the Main Menu. ● Select the Microphone menu option with the Up (6) / Down (4) button. ● Briefly press of the M (5) button to turn microphone on/off.
<p>Calibration</p> 	<p>Select calibration mode</p> <p>There are three calibration modes: Automatic(A), Manual (M) and Background (B). The selected calibration mode is displayed in the status bar (see Status Bar section).</p> <ul style="list-style-type: none"> ● Press and hold down the M (5) button to enter the Main Menu. ● Select the Calibration menu option with the Up (6) / Down (4) button. ● Briefly press of the M (5) button to enter the submenu. ● Press Up (6) / Down (4) button to select one mode from the following modes: <ul style="list-style-type: none"> - Automatic. The software determines the need for calibration in automatic mode. The calibration process starts automatically. - Manual. The user independently determines the need for calibration based on the quality of the observed image. - Background. Close the lens cover before starting the calibration. ● Briefly press M button to confirm your selection.







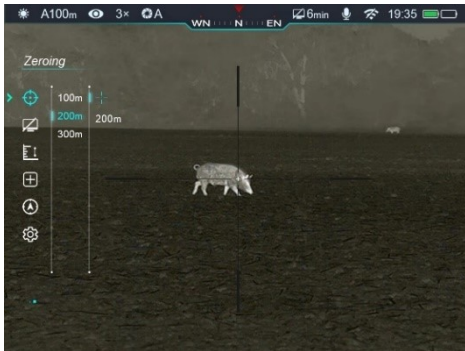





<p>Compass</p> 	<p>Turn on/off the digital Compass function</p> <ul style="list-style-type: none"> ● Press and hold down the M (5) button to enter the Main Menu. ● Select the Compass menu option with the Up (6) / Down (4) button. ● Briefly press of the M (5) button to turn the digital compass on/off. ● When compass function is turned on, it will reveal in the center of top status bar. 				
<p>Motion Sensor</p> 	<p>Turn on/off the gravity sensor</p> <ul style="list-style-type: none"> ● Press and hold down the M (5) button to enter the Main Menu. ● Select the Motion Sensor menu option with the Up (6) / Down (4) button. ● Briefly press of the M (5) button to turn the motion sensor on/off. ● Two scales are displayed on the both sides of the screen when the motion sensor is on. ● The left scale shows tilt angle, and the right one shows pitch angle. 				
<p>Reticle</p> 	<p>Setting zeroing profile, reticle type and reticle color.</p> <ul style="list-style-type: none"> ● Press and hold down the M (5) button to enter the Main Menu. ● Select the Reticle menu option with the Up (6) / Down (4) button. ● Briefly press of the M (5) button to enter the reticle submenu as below. <table border="1" data-bbox="405 1118 2076 1297"> <tr> <td data-bbox="405 1118 703 1297"> <p>Zeroing Profile</p>  </td> <td colspan="2" data-bbox="710 1118 2076 1297"> <p>Select zeroing profile</p> <ul style="list-style-type: none"> ● Select Zeroing Profile option with the Up (6) / Down (4) button. ● Briefly press of the M (5) button to enter the zeroing profile submenu. </td> </tr> </table>		<p>Zeroing Profile</p> 	<p>Select zeroing profile</p> <ul style="list-style-type: none"> ● Select Zeroing Profile option with the Up (6) / Down (4) button. ● Briefly press of the M (5) button to enter the zeroing profile submenu. 	
<p>Zeroing Profile</p> 	<p>Select zeroing profile</p> <ul style="list-style-type: none"> ● Select Zeroing Profile option with the Up (6) / Down (4) button. ● Briefly press of the M (5) button to enter the zeroing profile submenu. 				

	<ul style="list-style-type: none"> ● Select one of three Profiles (marked with the letters A, B, C) with a short press of the Up (6) / Down (4) button. ● Briefly press of the M (5) button to confirm your selection. ● The name of the selected profile appears in the status bar at the top of the display. 	
<p>Reticle Type</p> 	<p>Select reticle type</p> <ul style="list-style-type: none"> ● Select Reticle Type option with the Up (6) / Down (4) button in the reticle submenu. ● Briefly press of the M (5) button to enter the Reticle Type submenu. ● Select the desired reticle type in the list of seven reticle types with short pressing the Up (6) / Down (4) button. ● The reticle types change as the cursor goes down the reticle type list. ● Confirm your selection with a short press of the M (5) button. 	
<p>Reticle Color</p> 	<p>Select reticle color</p> <ul style="list-style-type: none"> ● Select Reticle Color option with the Up (6) / Down (4) button in the reticle submenu. ● Briefly press of the M (5) button to enter the Reticle Color submenu. 	

		<ul style="list-style-type: none"> ● Select the desired reticle color among white, black, red and green with short pressing the Up (6) / Down (4) button. ● The reticle color changes as the cursor goes down the reticle color list. ● Confirm your selection with a short press of the M (5) button. 	
<p>Zeroing</p> 	<p>To zero your riflescope, you need to set a zeroing profile and zeroing distance first. Geni series support the zeroing distance in the range of 1 to 999 m.</p> <ul style="list-style-type: none"> ● Press and hold down the M (5) button to enter the Main Menu. ● Select the Zeroing menu option with the Up (6) / Down (4) button. ● Briefly press the M (5) button to enter the zeroing submenu (zeroing distance selection). ● Select one Zeroing Distance based on the preset target distance with the Up (6) / Down (4) button. The default values are 100m, 200m, 300m ● Press M (5) button briefly to enter Zeroing Distance submenu as follows. 		
	<p>Zeroing</p> 	<p>If the zeroing distance is the same as the preset distance, you can zero your riflescope directly as follows.</p> <ul style="list-style-type: none"> ● In the Zeroing Distance submenu, select the Zeroing  menu option with the Up (6) / Down (4) button. ● Press M (5) button briefly to enter Zeroing function interface. ● The X and Y coordinates of the reticle are displayed in the upper left corner of the screen. ● Aim and shoot the target. 	

	<ul style="list-style-type: none"> ● Keep the reticle center the aiming point, then press and hold down the UP (4) and Down (4) button at the same time until a symbol of freeze ❄ appears on the left of the screen, and the image is frozen. ● Adjust the reticle position with the Up (6) / Down (4) button until the reticle matches the point of impact. Briefly press the Menu (5) button to switch the movement direction. ● For a detailed description of the reticle adjusting, please refer to the section 9 Zeroing. ● Press and hold the Menu (5) button to save the position of reticle and exit to the home screen. 	
<p>Reset Zeroing Distance</p> <p>▼ 000 ▲</p>	<p>If the zeroing distance is not same as the preset object, you can set the distance here.</p> <ul style="list-style-type: none"> ● Select a non-primary distance and enter the submenu for operation with a brief press of the M (5) button. ● Select Reset Zeroing Distance menu item with the Up (6) / Down (4) button. ● Short press the M (5) button to enable resetting the zeroing distance. Two triangle icons will appear above and below the number 0. ● Reset the value of the number from 0 to 9 with the Up (6) / Down (4) button. ● Press the M (5) button briefly to switch among the three numbers. ● After resetting, press and hold the M (5) button to save and exit. 	

	<ul style="list-style-type: none"> ● The new zeroing distance appears in the status bar at the top of the display.
<p>Standby</p> 	<p>Set standby status and time</p> <ul style="list-style-type: none"> ● Press and hold down the M (5) button to enter the Main Menu. ● Select the Standby menu option with the Up (6) / Down (4) button. ● Briefly press the M (5) button to enter the Standby submenu. ● Short press the Up (6) / Down (4) button to select one of four options (2min, 4min, 6min, off). ● Confirm your selection with a short press of M (5) button and reveal in the status bar at the top of the display. ● If the off is selected, it means the standby mode is turned off. 
<p>Range Reference</p> 	<p>Setting effective range, the target type and height</p> <ul style="list-style-type: none"> ● Press and hold down the M (5) button to enter the Main Menu. ● Select the Range Reference menu option with the Up (6) / Down (4) button. ● Briefly press the M (5) button to enter the Range Reference submenu. ● The order from left to right is effective range, the target type and height. ● Switch item among the three functions with a briefly press of the M (5) button. ● When the item is selected, the icon turns blue and a pair of triangles appear above and below the icon. ● Press the Up (6) / Down (4) to set the parameter of the item. There are five prey type for selection, including deer (), wild boar 

	<p>() , coyote () , hare () and custom (). Each prey type corresponds to a default height with a default effective range of 100m. The corresponding default height is 1.7m for deer,0.9m for wild boar,0.5m for coyote, and 0.2m for hare.</p> <ul style="list-style-type: none"> ● When short pressing the Up (6) / Down (4) button, the value of the prey height will change by 0.1m every time, and the value of the effective range changes 5m, and when long pressing will change continually. ● Press and hold the M (5) button to save the settings and exit to the main menu.
<p>Pixel Defect Correction</p> 	<p>Defect pixels are pixels that do not change brightness compare with others on the image, they are either brighter or darker than surrounding pixels. Geni series offer the possibility of removing any defective pixels on the sensor using software, as well as to cancel any deletion.</p> <ul style="list-style-type: none"> ● Press and hold down the M (5) button to enter the Main Menu. ● Select the Pixel Defect Correction menu option with the Up (6) / Down (4) button. ● Briefly press the M (5) button to enter the Pixel Defect Correction interface. ● A small cross cursor instead of the reticle will appear on the center of the screen. ● The Picture in Picture (PIP) window will appear on the lower left corner of the screen. ● On the right of PIP window, there are some prompts showing the movement direction of the cursor in X-axis (horizontal), Y-axis (vertical) and number of corrected pixels. ● Move the cursor to align with the defective pixel with a short or long press the Up (6) / Down (4) button. Press the Up (6) button to move the reticle right or up and the Down (4) button to move the reticle left or down. Short press to move one pixel every time and long press to <div data-bbox="1615 646 2083 997"> </div> <div data-bbox="1615 1024 2083 1372"> </div>

	<p>move ten pixels once.</p> <ul style="list-style-type: none"> ● Press the M (5) button briefly to switch the direction between X-axis and Y-axis. ● Delete the defective pixel with a short press of the Power (7) button When the pixel has been successful deleted, the Add message will appear on the PIP window for a short time. ● Then, delete the next defective pixel by moving the cursor across the display. ● Press the Power (7) button briefly in the same position as the calibrated defective pixel to cancel the pixel correction, and the Del message will appear on the PIP window for a short time. But it is only limited to not exiting this correction. ● The amount of defect pixels changes each time adding or deleting pixels correction. ● The PIP and the prompt information will move to the upper left of the screen when cursor moves near the lower left corner. ● Press and hold the M (5) button until display shows “Do you want to save these settings?” and “Yes” and “No” options. ● Press the Up (6) / Down (4) button briefly to select ‘Yes’ to save and exit, or select ‘No’ to cancel saving and exit. ● Confirm your selection with a short press of M (5) button. ● If Yes is selected, a 5-second Saving countdown appears on the screen. It will exit to the home screen after the prompt Saved successful appears.
<p>Compass</p>	<p>Calibrate the digital compass</p>

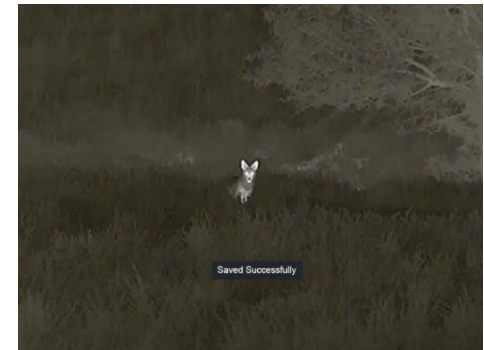
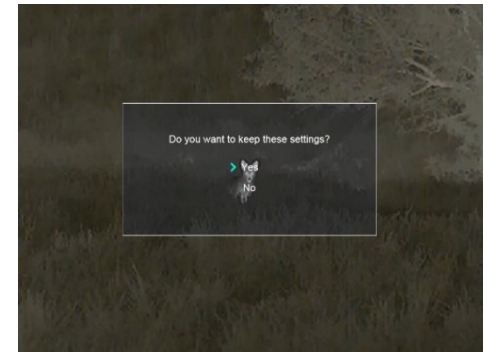

Calibration



- Press and hold down the **M (5)** button to enter the Main Menu.
- Select the **Compass Calibration** menu option with the **Up (6) / Down (4)** button.
- Briefly press the **M (5)** button to enter the **Compass Calibration** submenu.
- An icon like a triaxial coordinate system appears on the screen.
- Follow the icon prompt to rotate the riflescope along three axes at least 360 degrees each axis in the 15 seconds.
- After 15s, the calibration is finished and exit to the home screen.



Settings



Select general settings

- Press and hold down the **M (5)** button to enter the Main Menu.
- Select the **Settings** menu option with the **Up (6) / Down (4)** button.
- Briefly press the **M (5)** button to enter the submenu.
- This menu item allows you to configure the following settings.





Date



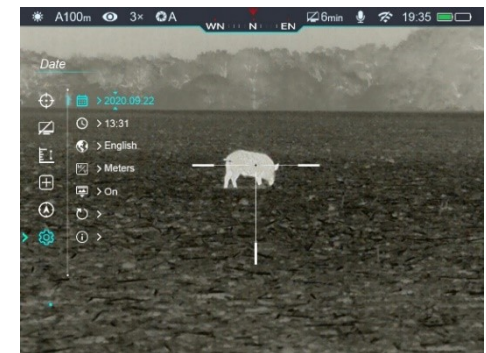





Date setting

- In the **Settings** submenu, briefly press the **M (5)** button to active the **Date** submenu. Two triangle icons will appear above and below the value.
- Date format is displayed as **YY.MM.DD** format (2020.01.01).
- Select the correct value for the year, month and date with a short press of the **Up (6) / Down (4)** button.

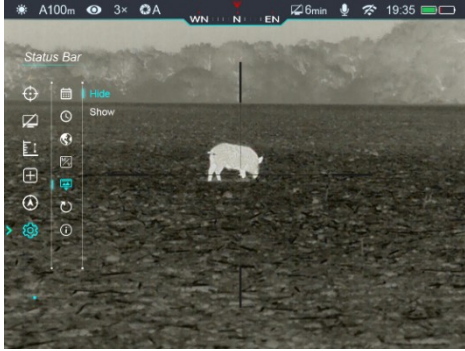

	<ul style="list-style-type: none"> ● Switch between digits with a short press of the M (5) button. ● Save selected date and exit the submenu with a long press of the M (5) button.
<p>Time</p> 	<p>Time setting</p> <ul style="list-style-type: none"> ● In the Settings submenu, briefly press the M (5) button to active the Time submenu. Two triangle icons will appear above and below the value. ● Time format is displayed as HH:MM in 24-hours format (14:48). ● Select the correct value for the hour and minute with a short press of the Up (6) / Down (4) button. ● Switch between digits with a short press of the M (5) button. ● Save selected date and exit the submenu with a long press of the M (5) button. 
<p>Languages</p> 	<p>Language selection</p> <ul style="list-style-type: none"> ● In the Settings submenu, select the Languages menu option with the Up (6) / Down (4) button. ● Enter the Languages submenu with a short press of the M (5) button. ● Select the desired language with a short press of the Up (6) / Down (4) button. Geni series support English and Russian two languages. ● Confirm your selection with a short press of the M (5) button. ● Submenu exit will take place automatically. 

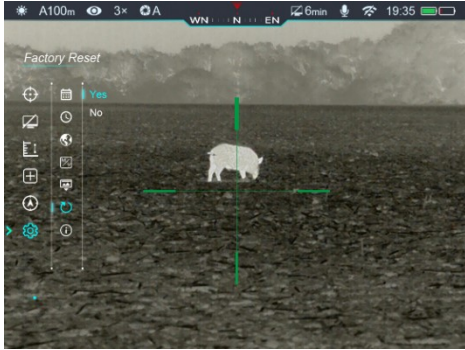
<p>Unit</p> 	<p>Units of measurement selection</p> <ul style="list-style-type: none"> ● In the Settings submenu, select the Unit menu option with the Up (6) / Down (4) button. ● Enter the Unit submenu with a short press of the M (5) button. ● Select the desired unit between meter and yard with a short press of the Up (6) / Down (4) button. ● Confirm your selection with a short press of the M (5) button. ● Submenu exit will take place automatically. 	
<p>Status Bar</p> 	<p>Set status bar to show or hide</p> <ul style="list-style-type: none"> ● In the Settings submenu, select the Status Bar menu option with the Up (6) / Down (4) button. ● Enter the Status Bar submenu with a short press of the M (5) button. ● Briefly press the Up (6) / Down (4) button to select Hide or Show. ● Confirm your selection with a short press of the M (5) button. ● Submenu exit will take place automatically. 	
<p>Factory Reset</p> 	<p>Reset to Factory Settings</p> <ul style="list-style-type: none"> ● In the Settings submenu, select the Factory Reset menu option with the Up (6) / Down (4) button. ● Enter the Factory Reset submenu with a short press of the M (5) button. ● Briefly press the Up (6) / Down (4) button to select Yes or No. 	

	<ul style="list-style-type: none"> ● Confirm your selection with a short press of the M (5) button. ● The riflescope will reboot If Yes is selected. ● If No is selected, the action will be cancelled and will return to the submenu. <p>The following settings will be returned to the defaults:</p> <ul style="list-style-type: none"> - Image mode: White Hot; - Zeroing: A100 - Ultraclear mode: Off; - Magnification: GL35: 3.0x; GH35: 2.0x GL50: 4.0x; GH50: 3.0x - Calibration mode: Automatic; - Wi-Fi: Off - Digital Compass: Off - Gravity Sensor: Off - Standby: Off; - Language: English - Units of Measure: Meter - Status Auto Hiding: Off 	
<p>Info</p> 	<p>Show device information</p> <ul style="list-style-type: none"> ● In the Settings submenu, select the Info menu option with the Up (6) / Down (4) button. ● The relevant information of riflescope will be shown by a short press of the M (5) button. ● This item allows the user to view the following information about the riflescope: the product model, GUI version, SYS Info, Boot version, FPGA, PN and SN number of the riflescope, Hardware version. ● Press and hold the M (5) button to return to the submenu. 	

17 PIP Function

The PIP (Picture in Picture) function allows you to see both a magnified image in a particular window and the main image.

- Press the **Zoom (6) + Menu (5)** button in the home screen to switch the PIP function on /off.
- When the main image is enlarged with a short press of the **Zoom (6)** button, the PIP image will be enlarged 2× synchronously.
- For example, when the magnification of the main image is 4×, 8×, 12×, 16×, the corresponding magnification of the PIP image is 8×, 16×, 24×, 32×.

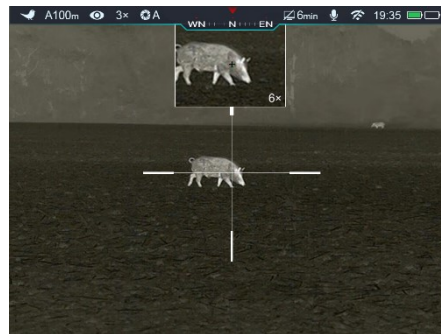

same time to enter the stadiametric ranging interface, and two horizontal lines will appear on the upper and lower positions of the cursor.

- Locate the object in the middle of the lines, then move the lines to locate the target between lines by the **Up (6) / Down (4)** button.
- The approximate distance of the target is displayed on the left of the screen.
- Short press the **Up (6) + M (5) + Down (4)** buttons at the same time to switch the unit between cm/m and inch/yard.



18 Stadiametric Rangefinder

Geni series is equipped with a stadiametric rangefinder, which allows you to estimate the approximate distance to an object, if its size is known.

- In the home screen, press and hold the **Up (6) + M (5)** buttons at the

19 Range Notification

- In the home screen, long press **Up (6)** button to enter the range notification interface.
- In the range notification interface, the prey type, height and effective range is displayed on the bottom. The measurement lines become two

horizontal lines which cannot be moved.

- The distance between two horizontal lines indicates the height mapped to the display of the current ranging settings.
- When the object is higher than the two horizontal lines distance, it means the object is in the effective range.
- In the range notification interface, it is possible to operate the device, such as, you can operate the prey settings in the main menu by long pressing the **M (5)** button, referring to the Section **Main menu - Stadiametric Rangefinder Setting**.
- Long press the **Up (6)** buttons again to exit from the range notification interface and back to the home screen.



- Press and hold down the **M (5)** button to enter the Main Menu.
- Select the **Settings** menu option with the **Up (6) / Down (4)** button.
- Briefly press the **M (5)** button to enter the submenu.
- Select the **Status Bar** menu option with the **Up (6) / Down (4)** button.
- Enter the **Status Bar** submenu with a short press of the **M (5)** button.
- Briefly press the **Up (6) / Down (4)** button to select **Hide** or **Show**.
- Confirm your selection with a short press of the **M (5)** button.
- When the selecting is **Hide**, the GUI icons in the interface including the status bar will be automatic hidden after 8 seconds without any operation. Only the image and the reticle will be displayed.
- The GUI information will be displayed again with the press of any button.
- Only after the GUI is displayed, the button and menu can be manipulated.

20 Status Bar Hiding

This function enables to show or hide the GUI information in the interface other than the reticle, so to make the image unobtrusive.

21 Wi-Fi Function

Geni series Is built-in Wi-Fi module for wireless communication with mobile devices (smartphone or tablet).

- Press and hold down the **M (5)** button to enter the Main Menu.
- Select the **Wi-Fi** menu option with the **Up (6) / Down (4)** button.
- Turn Wi-Fi function on /off with a short press of **M (5)** button.
- The riflescope is recognized by an external device under the name "Geni_xxxxx-xxxxxx", xxxxx-xxxxxx is the SN code of the device that consist of numbers and letters.
- Select this Wi-Fi signal, and enter the password (default is 12345678) on the mobile to set up the connection.
- When Wi-Fi is successfully connected, users can manipulate the device via App.
- Launch **InfiRay Outdoor** application on your mobile device (see **Update and APP** section).

Set Wi-Fi Name and Password

The Wi-Fi name and password of Tube series can be reset in the **InfiRay Outdoor** application.

- After connected with the mobile device, find and click the "setting" icon  in the **InfiRay Outdoor** to enter the setting interface.
- In the text box, enter and submit the new name (SSID) and password

of the Wi-Fi.

- It needs to reboot the device to take the new name and password effect.

Note! When factory Settings are restored, the Wi-Fi name and password are also restored to factory default settings.

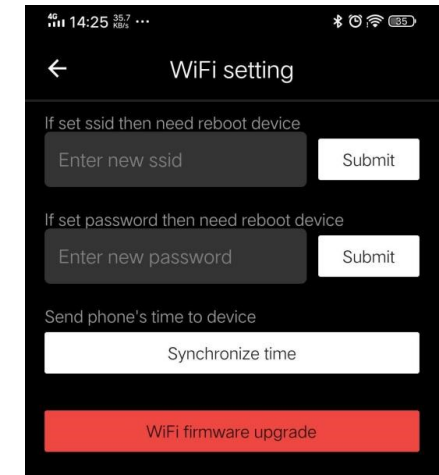

22 Updates and InfiRay Outdoor

Tube series thermal imaging riflescopes support **InfiRay Outdoor** technology, which allows you to transmit the image from the thermal imager to the smartphone or tablet via Wi-Fi in real time mode.

You can find detailed instructions on **InfiRay Outdoor** in the separate brochure at the site www.infirayoutdoor.com.

The design of the riflescope provides the software update option. Updating is possible via the **InfiRay Outdoor** application. Also, it is feasible to download and update software from the official website:

www.infirayoutdoor.com.

About InfiRay Outdoor

- You can get **InfiRay Outdoor** application in the official website, or search **InfiRay Outdoor** in App store, or scan the QR code to download **InfiRay Outdoor APP**.



- When installation completed, open InfiRay Outdoor application.
- If your riflescope is already connected with mobile device, please switch on the mobile data in mobile device. After connection, the update detection is performed automatically with a prompt in the application. Click 'Now' to download the updates or click 'Later' to update later.
- **InfiRay Outdoor** will automatically store the last connected device. So, if the riflescope has not connected with your mobile device, but linked to **InfiRay Outdoor** before, the update prompt will appear if there is an update when turning on **InfiRay Outdoor**. You can download the update first via mobile Wi-Fi and then connect the riflescope with mobile device to finish the update.

- After finishing the update, the device will root.
- Instructions for using InfiRay Outdoor can also be downloaded from the official website.

23 Technical Inspection

It is recommended to carry out a technical inspection each time before using the riflescope. Check the following:

- Check the external appearance of the device (there should be no cracks on the body).
- Check the condition of the lens and eyepiece (there should be no cracks, greasy spots, dirt or other deposits).
- Check the state of rechargeable battery (it should be charged).
- Check the controls/buttons (there should be in working order).

24 Maintenance

The maintenance should be carried out at least twice a year and includes

the following steps:

- Wipe the external surface of metal and plastic parts off dust with a cotton cloth. Silicone grease may be used for cleaning process.
- Clean the electric contacts and battery slots on the riflescope using a designed especially for this purpose.

non-greasy organic solvent.

- Check the optics of the lens and the eyepiece. If necessary, remove the dirt and sand from the optics (it is perfect to use a non-contact method). Cleaning of the exterior of the optics should be done with cleaners

25 Trouble Shooting

The table lists all the problems that may occur when operating the riflescope. Carry out the recommended checks and troubleshooting steps in the order shown in the table. If there are defects that are not listed in the table or it is impossible to repair the defect yourself, return the riflescope for repair service.

Fault	Probable Cause	Solution
Riflescope will not turn on.	Batteries are completely discharged.	Charge the battery.
Riflescope will not work with an external power supply.	USB cable is damaged.	Replace USB cable.
	External power source is discharged.	Check the external power source.
The image is fuzzy, not clear, not balanced, with strings	Calibration is required.	Perform image calibration according to the Calibration section of this manual.
The Image is too dark.	Brightness level is too low.	Adjust brightness of screen.
The GUI is clear, but the image is	The lens is not focused.	Adjust the image sharpness by rotating the lens adjuster.

fuzzy.	There is dust or condensate on the interior or exterior optical surfaces of the lens.	Wipe off the outside optical surfaces with a soft cotton cloth. Let the riflescope dry by leaving it in a warm environment for 4 hours.
 <p>The aiming reticle shifts after firing rounds.</p>	The riflescope is not mounted securely or the mount is not fixed on the riflescope.	<p>Check that the riflescope has been securely mounted.</p> <p>Make sure you are using the same type and caliber of the bullets as when the riflescope and weapon were initially zeroed.</p> <p>If your riflescope was zeroed in the summer and using in the winter (or the other way round), a slight shift of the zero point is possible.</p>
The image of the object being observed is missing.	Observation through glass.	Remove the glass from the field of vision.
The riflescope will not focus.	Wrong settings.	<p>Adjust the riflescope according to the Powering On and Image Setting section.</p> <p>Check the outer surfaces of the objective lenses and eyepiece and, where necessary, wipe them from dust, condensation, frost, etc.</p> <p>In cold weather, you can use special anti-fogging coatings (e.g., the same as for corrective glasses).</p>
The riflescope can't connect with the smartphone and tablet PC.	Wrong Wi-Fi password	Input correct password
	Too many Wi-Fi signals around the device.	Move the device to an area with no or fewer Wi-Fi signals
Wi-Fi signal is missing or interrupted	Smartphone or tablet is out of range of a strong Wi-Fi signal. Or there are obstacles	Replace the device until Wi-Fi signal is stable.

	between device and the smartphone or tablet (such as concrete wall).
Image quality is too low or the detection range is reduced.	These problems may occur due to the weather condition, such as snow, rain, fog etc.
When the riflescope is used in the low temperature conditions, the image quality of the surroundings is worse than in positive temperature conditions.	<p>In positive temperature conditions, objects being observed (surroundings and background) heat up differently because of thermal conductivity, thereby generating a high temperature contrast. Accordingly, image quality produced by the thermal imager will be higher.</p> <p>In low temperature conditions, object objects being observed (background) will cool down to roughly the same temperature, as a rule, and thus the temperature contrast is substantially reduced and image quality (zoom) goes down. This is a distinctive feature of the thermal imager.</p>

26 Legal and Regulatory Information

Wireless transmitter module frequency range:

WLAN: 2.412-2.472GHz (For EU)

Wireless transmitter module power<20dBm (only for EU)



IRay Technology Co., Ltd. thus declares that the Geni GL35R complies with the directives 2014/53/EU and 2011/65/EU.

The full text of the EU declaration of conformity as well as additional information are available at: www.infirayoutdoor.com.

This device may be operated in all member states of the EU.

FCC Statement

FCC ID: 2AYGT-2H-00

Labeling requirements

This device complies with part 15 of the FCC Rules. Operation is subject to the following two conditions: (1) This device may not cause harmful interference, and (2) this device must accept any interference received,

including interference that may cause undesired operation.

Information to the user

Any Changes or modifications not expressly approved by the party responsible for compliance could void the user's authority to operate the equipment.

Note: The manufacturer is not responsible for any radio or TV interference caused by unauthorized modifications to this equipment. Such modifications could void the user's authority to operate the equipment.

Note: This equipment has been tested and found to comply with the limits for a Class B digital device, pursuant to part 15 of the FCC Rules. These limits are designed to provide reasonable protection against harmful interference in a residential installation. This equipment generates uses and can radiate radio frequency energy and, if not installed and used in accordance with the instructions, may cause harmful interference to radio communications. However, there is no guarantee that interference will not occur in a particular installation. If this equipment does cause harmful interference to radio or television reception, which can be determined by turning the equipment off and on, the user is encouraged to try to correct

the interference by one or more of the following measures:

- Reorient or relocate the receiving antenna.
- Increase the separation between the equipment and receiver.
- Connect the equipment into an outlet on a circuit different from that to which the receiver is connected.
- Consult the dealer or an experienced radio/TV technician for help.

This equipment complies with FCC RF radiation exposure limits set forth for an uncontrolled environment.

Body-worn Operation

This device was tested for typical body-support operations. To comply with RF exposure requirements, a minimum separation distance of 0.5cm must be maintained between the user's body and the handset, including the antenna. Third-party belt-clips, holsters, and similar accessories used by this device should not contain any metallic components. Body accessories that do not meet these requirements may not comply with RF exposure requirements and should be avoided. Use only the supplied or an approved antenna.