



## Quick Start Guide

V1.0

# TUBE

Thermal Imaging  
Riflescope

TL35 V2 / TL50

## Attention!

Please read this guide before using the product,  
and keep the guide for future reference.

You can scan the QR code below to enter the official  
website ([www.infirayoutdoor.com](http://www.infirayoutdoor.com)) to view and  
download the detailed operating manual.



RoHS



## **| Package Contents**

- Tube TL35 V2 / TL50 Thermal Imaging Scope
- Eyeshade
- Picatinny rail mount
- Power adapter
- Type C cable
- Lens cloth
- Heated target for zeroing
- Portable bag

## **| InfiRay Outdoor**

Search InfiRay Outdoor in App store or scan the following QR code to download the InfiRay Outdoor App to transmit the image via Wi-Fi from your Tube to a smart phone or tablet.



**InfiRay Outdoor**



# Components and Controls

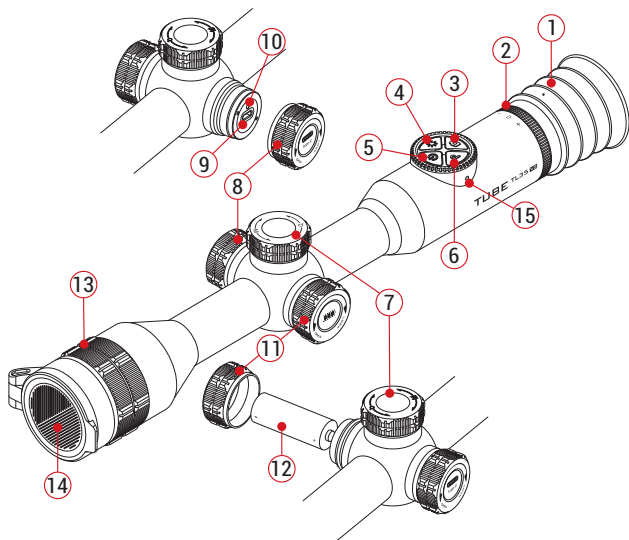









- |                                     |                        |
|-------------------------------------|------------------------|
| 1. Eyeshade                         | 8. USB cover           |
| 2. Eyepiece diopter adjustment ring | 9. Type C port         |
| 3. Camera button                    | 10. LED indicator      |
| 4. Display brightness button        | 11. Battery slot cover |
| 5. Power button                     | 12. 18500 battery      |
| 6. Image mode button                | 13. Lens focus ring    |
| 7. Controller                       | 14. Lens cap           |
|                                     | 15. Microphone         |

# | Getting Started

- Remove the lens cap **(14)**.
- Press and hold the **Power (5)** button for 2s to start the device and wait for 3s to complete the startup.
- Rotate the eyepiece diopter adjustment ring **(2)** until the icons on the display become clear.
- Rotate the lens focus ring **(13)** of the objective lens to focus on the object to be observed.
- **Image settings:** on the home screen, short press the **Image Mode (6)** button to set the image mode, short press the **Display Brightness (4)** button to set the display brightness, rotate the **Controller (7)** to adjust the visual magnification.
- On the home screen, short or long press the **Controller (7)** to enter the shortcut menu or main menu for more functional operations.
- On the home screen, short press **Power (5)** button for image calibration. When performing background calibration, please cover the lens cap **(14)** first and finish the background calibration after 2s. Set the image calibration mode in the main menu.
- Press the **Power (5)** button for 3s to enter the power-off interface. When the countdown reaches 0, release the button to power off the device, otherwise, the device will enter the standby mode.

# Button Operation

Button	Current status	Short press	Long press
	Powered off	--	Power on the device
	Home screen	Image calibration	Power off / Standby the device
	Standby mode	Wake up the device	--
	Single ranging is on	Perform single ranging	--
	Main menu interface	Return to the previous menu without saving	--
	Defective pixel calibration interface	Add / Delete defective pixels	--
	Home screen	Switch the image mode	Turn the PIP function on/off
	Home screen	Take a photo	Start / Stop a video recording

Button	Current status	Short press	Long press
	Home screen	Adjust the display brightness	Turn the stadiametric rangefinder function on/off *
<b>P+</b> 	Home screen	Switch the ranging mode between single ranging and continuous ranging	Turn the laser rangefinder function on/off when connected with the laser rangefinder module
<b>P+</b> 	Zeroing interface	--	Freeze the picture
 <b>+</b> 	Home screen	--	Turn the reticle and its functions on/off
	Zeroing interface	--	Return reticle to the center

★ When connected with the laser rangefinder module, long pressing the **Display Brightness button** is to turn on/off the laser indicator on the rangefinder module.

Button	Current status	Short press	Long press	Rotate
	Home screen	Enter the shortcut menu interface	Enter the main menu interface	Adjust the image magnification
	Shortcut menu interface	Adjust the parameter of the function		
	Main menu interface	Confirm selection / Enter the submenu	Save and return to the home screen	Switch the menu option
	Pixel defect calibration / Zeroing interface	Switch the movement direction		Move the reticle: Clockwise-left/down; Counterclockwise-right/up

# Power Supply

The Tube series uses a dual power supply system - a built-in rechargeable lithium-ion battery pack and a replaceable 18500 battery, with dual battery power for up to 15 hours of normal operating time. The battery should be fully charged before first use.

## Installing the replaceable 18500 battery

- Turn anticlockwise to remove the battery slot cover (11).
- Install one 18500 battery (12) according to the electrode label in the battery compartment, with the positive electrode facing inward and the negative electrode facing outward.
- Place the battery slot cover (11) back and tighten it.

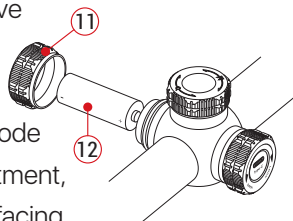

## Charging the built-in battery

If the built-in battery icon turns red during use, it indicates that the battery power is insufficient. Please charge the built-in battery in time to avoid shortening the battery life.

- Open the USB cover (8) by turning it anticlockwise.
- Connect the Type-C plug of USB cable (16) to the Type-C port (9) in the body of Tube

- Connect the other USB plug of the data cable (16) to the power adapter (17) and plug the adapter (17) into the power socket (18) of 100-240V for charging.
- During charging, a charging sign appears on the battery icon and the LED indicator (10) turns red. When the indicator (10) turns green, the charging is completed.

**Note:** The USB port can only be used for charging the built-in battery pack.

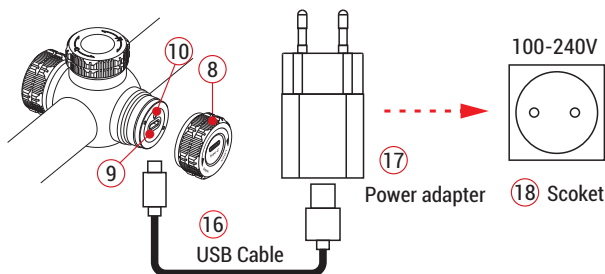

### Switching between two kinds of batteries

- Except for the built-in battery pack, if the replaceable 18500 battery is installed, two battery icons will be displayed on the top status bar of the screen at the same time. The right battery icon represents the power of the built-in battery, and the left one represents the power of the replaceable 18500 battery. The icon for the battery supplying power is



green and the other is gray.



- When both batteries are full of power, the replaceable 18500 battery is preferred; when the power of the replaceable battery is insufficient, the internal battery pack will be automatically used for power supply.
- If no 18500 battery is installed, only one battery icon will be displayed on the status bar, indicating the power of the built-in battery.
- In use, if the power of the replaceable battery is insufficient, the battery can be replaced without shutting down the device. At this point, the internal battery will be automatically used for power supply.
- When the device is connected to the external power supply, the external battery is used for power supply, while the internal battery pack is charged. At this point, the internal battery icon on the right side will turn green.

# Specifications

Model	TL35 V2	TL50
<b>Detector Specifications</b>		
Type	Uncooled Vox	
Resolution, pixels	384 × 288	
Pixel size, $\mu\text{m}$	12	
NETD, mK	≤ 40	
Frame rate, Hz	50	
<b>Optical Specifications</b>		
Objective lens, mm	35	50
Field of view, $^{\circ}$	7.5 × 5.6	5.2 × 4.0
Linear field of view (H×V), m at 100m	13.1 × 9.9	9.2 × 6.9
Magnification, ×	3.0 ~ 12.0	4.0 ~ 16.0
E-zoom, ×	1 ~ 4	
Eye relief, mm	70	
Exit pupil diameter, mm	6	
Diopter adjustment, D	-4 ~ +4	
Detection distance, m (Target size: 1.7m×0.5m, P(n)=99%)	1800	2600

Model	TL35 V2	TL50
<b>Display</b>		
Type	OLED	
Resolution, pixels	1024 × 768	
<b>Power Supply</b>		
Battery type	Built-in battery / 6600mAh + replaceable 18500 battery / 3.7V	
Max. battery life*, h	15	
External power supply, V	5 (Type C )	
<b>Functions</b>		
Wi-Fi / APP	Support (InfiRay outdoor)	
Photo / Video recorder	Support	
MIC	Support	
Bluetooth	Support	
<b>Physical Specifications</b>		
IP rating	IP67	
Memory capacity, GB	32	

Model	TL35 V2	TL50
Operating temperature, °C	-20 ~ +50	
Max. recoil power on rifled weapon (Eo), Joules	6000	
Compatible mounts	Standard 30 mm rings	
Weight (without 18500 battery), g	≤ 950	≤ 985
Dimension, mm	385×85×75	390×85×75

- ★ The actual operating time depends on the density of Wi-Fi use, photographing, video recording, etc.
- Improvements may be made to the design and software of this product to enhance its user features without notice.
- The current version of the User Manual may be found on the website [www.infirayoutdoor.com](http://www.infirayoutdoor.com).

# **| Important Safety Information**

## **Environmental influences**

- Never point the lens of the device directly at intense heat sources such as the sun or laser equipment. The objective lens and eyepiece can function as a burning glass and damage the interior components.
- Avoid touching the metal surface (cooling fins) after exposure to sunlight or cold.

## **Ergonomics notes**

Take breaks after longer periods of use to avoid wrist pain.

## **Risk of swallowing**

Do not place this device in the hands of small children. Incorrect handling can cause small parts to come loose which may be swallowed.

## **Safety instructions for use**

- Handle the device with care: rough handling can damage the internal battery.
- Do not expose the device to fire or high temperatures.
- Install the batteries correctly according to the instruction on the device. Reverse connection is prohibited.
- If the device has been damaged, send the device to our after-sales service for repair.

## **User information on the disposal of electrical and electronic devices (private households)**

2012/19/EU (WEEE directive): Products marked with this



symbol cannot be disposed of as unsorted municipal waste in the European Union. For proper recycling, return this product to your local supplier upon the purchase of equivalent new equipment, or dispose of it at designated collection points. For more information see: [www.recyclethis.info](http://www.recyclethis.info).

### **Intended use**

The device is intended for displaying heat signatures during nature observation, remote hunting observations and for civil use. This device is not a toy for children.

Use the device only as described in this operating manual.

The manufacturer and the dealer accept no liability for damages which arise due to non-intended or incorrect use.

### **Function test**

- Before use, please ensure that your device has no visible damage.
- Test to see if the device displays a clear, undisturbed image.

### **Installing/removing the battery**

The Tube TL35 V2 / TL50 Thermal Imaging Scope is equipped with two power supply systems - one built-in battery pack and one replaceable 18500 battery. The built-in battery pack cannot be removed.

# **| Legal and Regulatory Information**

Wireless transmitter module frequency range:

**WLAN: 2.412-2.472GHz (For EU)**

Wireless transmitter module power < 20dBm (only for EU)



IRay Technology Co., Ltd. thus declares that the Tube Series Thermal Imaging Scope complies with the directives 2014/53/EU and 2011/65/EU. The full text of the EU declaration of conformity as well as additional information are available at: [www.infirayoutdoor.com](http://www.infirayoutdoor.com).

This device may be operated in all member states of the EU.

## **Regulatory information USA**

FCC ID: 2AYGT-2D-00

### **Labeling requirements**

This device complies with part 15 of the FCC Rules. Operation is subject to the following two conditions: (1) This device may not cause harmful interference, and (2) this device must accept any interference received, including interference that may cause undesired operation.

### **Information to the user**

Any Changes or modifications not expressly approved by the party responsible for compliance could void the user's authority to operate the equipment.

**Note:** The manufacturer is not responsible for any radio or TV

interference caused by unauthorized modifications to this equipment. Such modifications could void the user's authority to operate the equipment.

**Note:** This equipment has been tested and found to comply with the limits for a Class B digital device, pursuant to part 15 of the FCC Rules. These limits are designed to provide reasonable protection against harmful interference in a residential installation. This equipment generates uses and can radiate radio frequency energy and, if not installed and used in accordance with the instructions, may cause harmful interference to radio communications. However, there is no guarantee that interference will not occur in a particular installation. If this equipment does cause harmful interference to radio or television reception, which can be determined by turning the equipment off and on, the user is encouraged to try to correct the interference by one or more of the following measures:

- Reorient or relocate the receiving antenna.
- Increase the separation between the equipment and receiver.
- Connect the equipment into an outlet on a circuit different from that to which the receiver is connected.
- Consult the dealer or an experienced radio/TV technician for help.

This equipment complies with FCC RF radiation exposure limits set forth for an uncontrolled environment.



## **Body-worn Operation**

This device was tested for typical body-support operations.

To comply with RF exposure requirements, a minimum separation distance of 0.5cm must be maintained between the user's body and the handset, including the antenna.

Third-party belt-clips, holsters, and similar accessories used by this device should not contain any metallic components.

Body accessories that do not meet these requirements may not comply with RF exposure requirements and should be avoided. Use only the supplied or an approved antenna.

InfiRay Outdoor • **Tube TL35 V2 / TL50** • Quick Start Guide



## **IRay Technology Co., Ltd.**

**Add:** 11th Guiyang Street, YEDA, Yantai, P.R. China

**Tel:** 0086-400-999-3800

**Email:** [infirayoutdoor@infiray.com](mailto:infirayoutdoor@infiray.com)

**Web:** [www.infirayoutdoor.com](http://www.infirayoutdoor.com)

